



High Accuracy 2-Colour Remote Type Display Digital Pressure Switch



Compact Pressure Sensor for Pneumatics Series PSE540

- Weight **2.9 g**
- Dimension **9.6x20.8x18 mm**

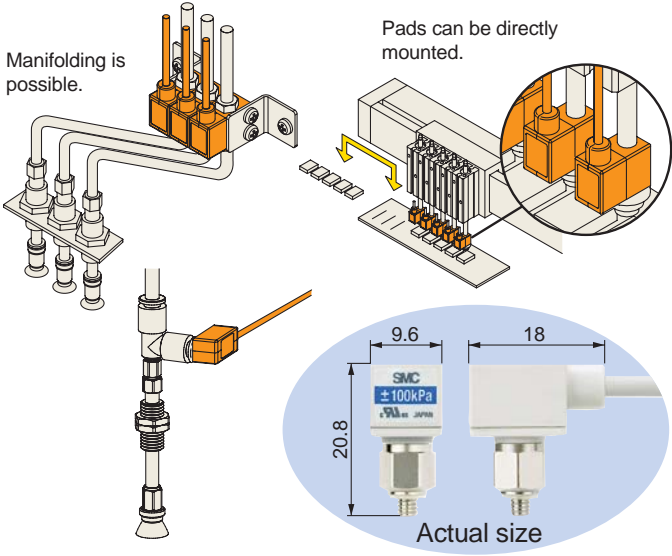

Pressure Sensor Controller Series PSE300

- Response Time **1ms**
- Set Pressure Resolution **1/1000**

Can be mounted in close proximity with each other either horizontally or vertically.

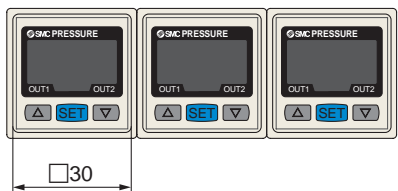

Connection

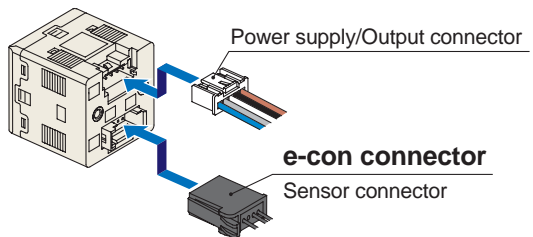

2 outputs + Analogue output or auto shift input

Pressure Sensor for General Purpose Fluids Series PSE560

- IP65**
- Wetted Material **sus316L**
- Copper-free
- Oil-free (single diaphragm)

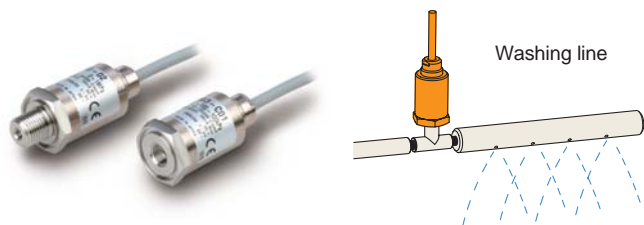

Variations

Compact Pressure Sensor for Pneumatics *Series PSE540*

P.1

Male thread type



M3 R1/8 (with M5 female thread)
M5 NPT1/8 (with M5 female thread)

Plug-in reducer type



ø4 plug-in reducer
ø6 plug-in reducer

M5 female thread, through type



M5 M5 (with mounting hole)

Pressure Sensor for General Purpose Fluid *Series PSE560*

P.4

Male thread type



R1/8, 1/4 (with M5 female thread)
NPT1/8, 1/4 (with M5 female thread)
URJ1/4, TSJ1/4

Female thread type



Rc1/8

Applicable fluid example

Argon	Nitrogen
Air containing drainage	Hydraulic fluid
Ammonia	Silicone oil
Freon	Lubricating oil
Carbon dioxide	Fluorocarbon

Controller

Series PSE300

P.6



Functions

- Auto shift function
- Auto preset function
- Precision indicator setting
- Peak and bottom display function
- Key lock function
- Reset function
- Error indication function
- Unit display switching function
- Anti-chattering function

Series		Rated pressure range			
For pneumatics	PSE541	0 to -101 kPa	Vacuum	-101 kPa	0
	PSE543	-100 to 100 kPa	Compound pressure	-100 kPa	100 kPa
For general purpose fluids	PSE560	0 to 1 MPa	Positive pressure	0	1 MPa
	PSE561	0 to -101 kPa	Low pressure	-101 kPa	0
	PSE563	-100 to 100 kPa	Compound pressure	-100 kPa	100 kPa
	PSE564	0 to 500 kPa	Positive pressure	0	500 kPa

Compact Pressure Sensor for Pneumatics

Series PSE540

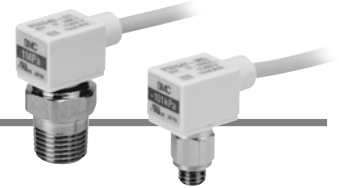

How to Order

Pressure sensing range

1	Vacuum (0 to -101 kPa)
3	Compound pressure (-100 to 100 kPa)

PSE54 **1** - **M3** - []

Options (Connector)

Nil	C1	C2
Without	Connector for PSE200 multiple channel pressure controller 1 pc. 	Connector for PSE300 multiple channel pressure controller 1 pc.

Note) At the factory, the connector is not connected to the cable, but packed together with it for shipment.

Port size

M3	M3 x 0.5		IM5	M5 female thread, through type	
M5	M5 x 0.8		IM5H	M5 female thread, through type (with mounting hole)	
01	R1/8 (with M5 female thread)				
N01	NPT1/8 (with M5 female thread)				
R04	ø4 plug-in reducer				
R06	ø6 plug-in reducer				

Options/Part No.

Description	Part no.	Note
Connector for PSE200	ZS-26-E-4	1 pc.
Connector for PSE300	ZS-28-C	1 pc.

Specifications

Conforms to CE marking and UL (CSA) standards.

Model	PSE541	PSE543
Rated pressure range	0 to -101 kPa	-100 to 100 kPa
Proof pressure	500 kPa	
Fluid	Air, No-corrosive gas, Non-flammable gas	
Power supply voltage	12 to 24 VDC ±10%, Ripple (p-p) 10% or less (with power supply polarity protection)	
Current consumption	15 mA or less	
Output specification	Analogue output 1 to 5 V (within rated pressure range), Output impedance: Approx. 1 kΩ	
Accuracy (ambient temperature of 25°C)	±2%F.S. or less	
Linearity	±0.4%F.S. or less	
Repeatability	±0.2%F.S. or less	
Power supply voltage effect	±0.8%F.S. or less	
Resistance	Enclosure	IP40
	Operating temperature range	Operating: 0 to 50°C, Stored: -20 to 70°C (with no condensation and no freezing)
	Operating humidity range	Operating/Stored: 35 to 85%RH (with no condensation)
	Withstand voltage	1000 VAC, 50/60 Hz for 1 minute between live parts and case
	Insulation resistance	50 MΩ between live parts and case (at 500 VDC)
	Vibration resistance	10 to 500 Hz at whichever is smaller of 1.5 mm amplitude or 98 m/s ² acceleration, in X, Y, Z directions, for 2 hours each (de-energized)
Impact resistance	980 m/s ² in X, Y, Z directions, 3 times each (de-energized)	
Temperature characteristics	±2%F.S. or less (based on 25°C)	

Piping specification

Model	M3	M5	01	N01	R04	R06	IM5	IM5H
Port size	M3	M5	R1/8 M5	NPT1/8 M5	ø4 plug-in reducer	ø6 plug-in reducer	M5 female thread, through type	M5 female thread, through type (with mounting hole)
Material	Case	Resin case: PBT Fitting: SUS303		Resin case: PBT Fitting: C3604BD		PBT	Resin case: PBT Fitting: A6063S-T5	
	Pressure sensing section	Pressure sensor: Silicone, O-ring: NBR						
Sensor cable	3 wire oval cable (0.15 mm ²)							
Weight	With sensor cable	42.4 g	42.7 g	49.3 g	41.4 g	41.6 g	43.3 g	44.1 g
	Without sensor cable	2.9 g	3.2 g	9.8 g	1.9 g	2.1 g	3.8 g	4.6 g

Series PSE540

Internal Circuit

PSE54□
 Voltage output type
 1 to 5 V
 Output impedance
 Approx. 1 kΩ

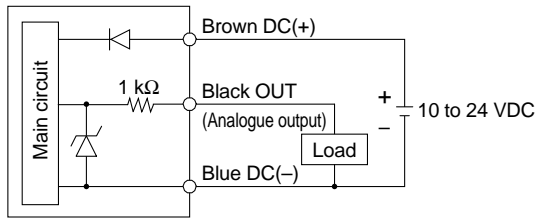

Dimensions

PSE54□-M3
 M5

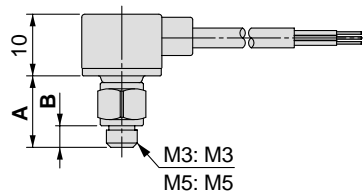
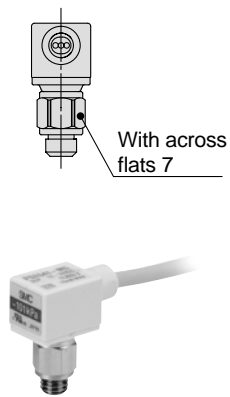

	PSE54□-M3	PSE54□-M5
A	10.8	11.5
B	3	3.5

PSE54□-R04
 R06

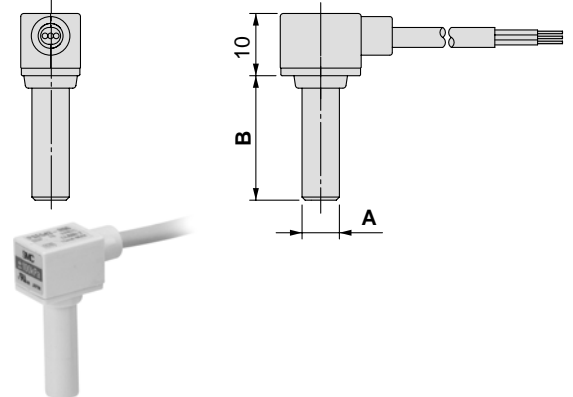

	PSE54□-R04	PSE54□-R06
A	∅4	∅6
B	18	20

Common dimensions

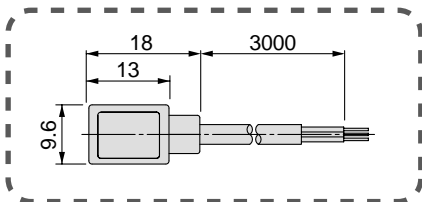

PSE54□-IM5

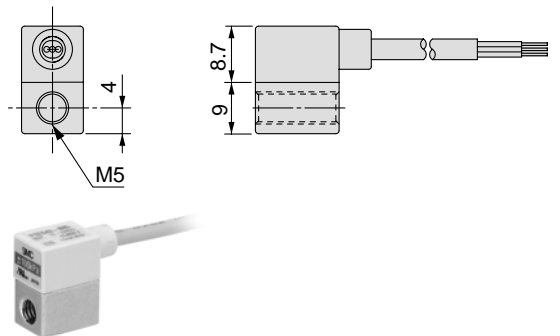

PSE54□-01
 N01

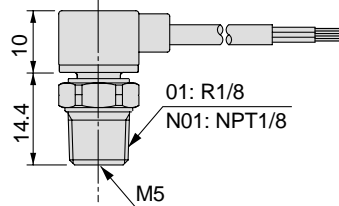
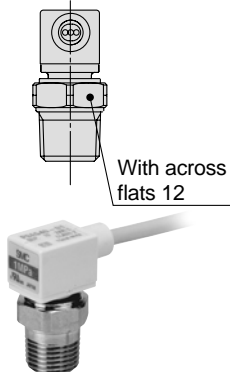

PSE54□-IM5H

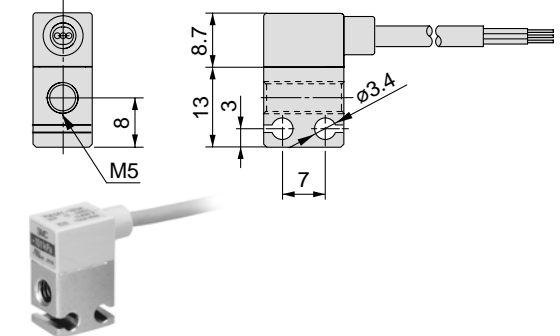

Pressure Sensor for General Purpose Fluids

Series PSE560

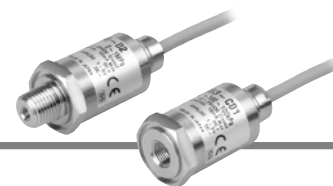

How to Order

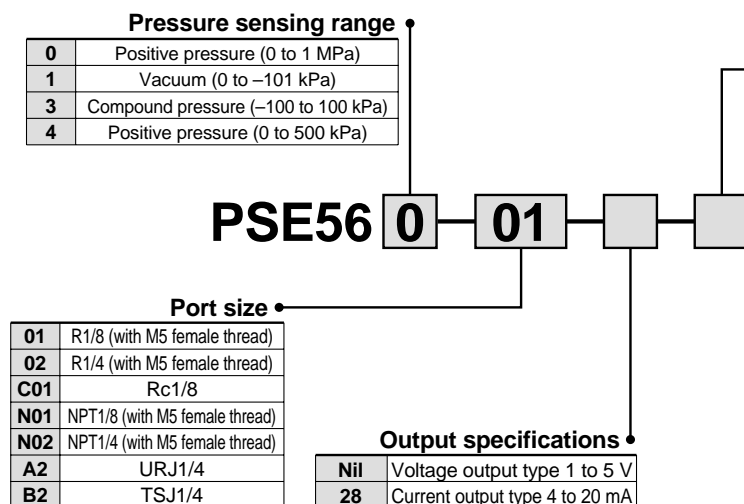

Note 1) Current output type cannot be connected to PSE20□ and PSE30□.
Note 2) The connector is not connected to the cable and is supplied loose at the time of shipment.

Options/Part No.

Description	Part no.	Note
Connector for PSE200	ZS-26-E-4	1 pc.
Connector for PSE300	ZS-28-C	1 pc.

Specifications

Conforms to CE marking and UL (CSA) standards.

Model	PSE560	PSE561	PSE563	PSE564
Rated pressure range	0 to 1 MPa	0 to -101 kPa	-100 to 100 kPa	0 to 500 kPa
Proof pressure	1.5 MPa	500 kPa	500 kPa	750 kPa

Model	PSE56□-□	PSE56□-□-28
Fluid	Fluid, including gas, that will not corrode SUS316L	
Power supply voltage	12 to 24 VDC ±10%, Ripple (p-p) 10% or less (with power supply polarity protection)	
Current consumption	10 mA or less	-
Output specification	Analogue output 1 to 5 V (within rated pressure range) Output impedance: Approx. 1 kΩ	Analog output 4 to 20 mA (within rated pressure range) Allowable load impedance: 500 Ω or less (at 24 VDC) 100 Ω or less (at 12 VDC)
Accuracy (ambient temperature of 25°C)	±1%F.S. or less	
Linearity	±0.5%F.S. or less	
Repeatability	±0.2%F.S. or less	
Power supply voltage effect	±0.3%F.S. or less	
Resistance	Enclosure	IP65
	Operating temperature range	Operating: -10 to 60°C, Stored: -20 to 70°C (with no condensation and no freezing)
	Operating humidity range	Operating/Stored: 35 to 85%RH (with no condensation)
	Withstand voltage	250 VAC for 1 minute between live parts and case
	Insulation resistance	50 MΩ between live parts and case (at 50 VDC)
	Vibration resistance	10 to 150 Hz at whichever is smaller of 1.5 mm amplitude or 20 m/s ² acceleration, in X, Y, Z directions, for 2 hours each (de-energized)
	Impact resistance	500 m/s ² in X, Y, Z directions, 3 times each (de-energized)
Temperature characteristics	±2%F.S. or less (0 to 50°C, based on 25°C), ±3%F.S. or less (-10 to 60°C, based on 25°C)	

Piping specification

Model	01	02	N01	N02	C01	A2	B2	
Port size	R1/8 M5	R1/4 M5	NPT1/8 M5	NPT1/4 M5	Rc1/8	URJ1/4	TSJ1/4	
Material	Case: C3604 + nickel plated, Piping port/pressure sensor: SUS316L							
Sensor cable	PSE56□-□: Oil proof 3-wire heavy-duty vinyl cable with air tube (0.2 mm ²) PSE56□-□-28: Oil proof 2-wire heavy-duty vinyl cable with air tube (0.2 mm ²)							
Weight	With sensor cable	193 g	200 g	194 g	201 g	187 g	203 g	193 g
	Without sensor cable	101 g	108 g	102 g	109 g	95 g	111 g	101 g

Series PSE560

Internal Circuit

PSE56□-□

Voltage output type
1 to 5 V
Output impedance
Approx. 1 kΩ

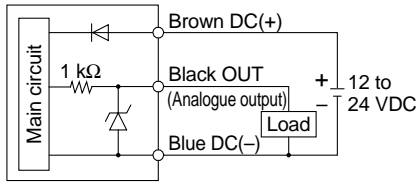

PSE56□-□-28

Current output type
4 to 20 mA
Allowable load impedance
500 Ω or less (at 24 VDC)
100 Ω or less (at 12 VDC)

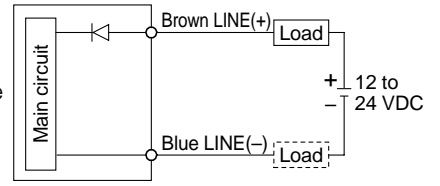

* Install the load either on the LINE (+) or LINE (-) side.

Dimensions

PSE56□-01 / PSE56□-N01 PSE56□-02 / PSE56□-N02

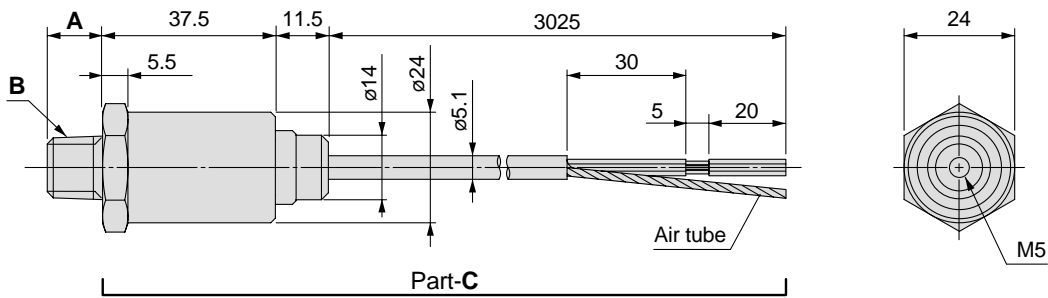

* The dimensions of Part C are common to all PSE56□ models.

PSE56□-C01

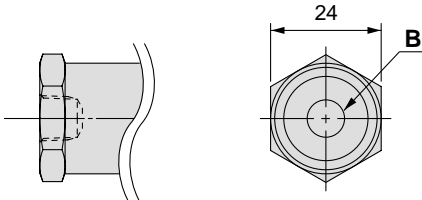

PSE56□-A2

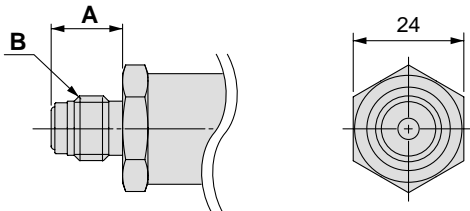

Part no.	A	B
PSE56□-01	8.2	R1/8
PSE56□-02	12	R1/4
PSE56□-N01	9.2	NPT1/8
PSE56□-N02	12.2	NPT1/4
PSE56□-C01	-	Rc1/8
PSE56□-A2	15.5	URJ1/4
PSE56□-B2	9.5	TSJ1/4

PSE56□-B2

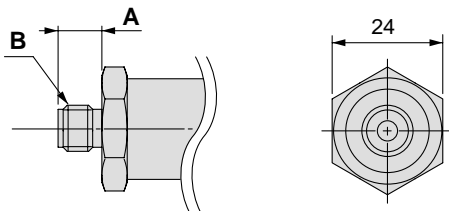

Pressure Sensor Controller

Series PSE300



How to Order

Input/Output specifications

0	NPN2 output + 1-5 V output
1	NPN2 output + 4-20 mA output
2	NPN2 output + Auto shift input
3	PNP2 output + 1-5 V output
4	PNP2 output + 4-20 mA output
5	PNP2 output + Auto shift input

Unit specifications

Nil	With unit display switching function
M	Fixed SI unit Note)

Note) Fixed units

For vacuum & low pressure & low differential pressure & compound pressure: kPa

Positive pressure: MPa (for 1 MPa)
kPa (for 500 kPa)

PSE30 0 M

Option 1

Nil	Without cable Power supply/Output connection cable
L	<p>Power supply/ Output connection cable ZS-28-A</p>

Option 3

Nil	Without connector Sensor connector
C	<p>Sensor connector (e-con connector) ZS-28-C</p>

Option 2

Nil	Without bracket/panel mount adapter/front protective cover
A	<p>Bracket</p> <p>M3 x 5L Bracket</p>
B	<p>Panel mount adapter</p> <p>Panel Panel mount adapter Mounting screw (M3 x 8L) (accessory)</p>
D	<p>Panel mount adapter + Front protective cover</p> <p>Panel Front protective cover Panel mount adapter Mounting screw (M3 x 8L) (accessory)</p>

Options/Part No.

Description	Part no.	Note
Power supply/Output connection cable	ZS-28-A	
Bracket	ZS-28-B	With M3 x 5L (2 pcs.)
Sensor connector	ZS-28-C	1 pc.
Panel mount adapter	ZS-27-C	With M3 x 8L (2 pcs.)
Panel mount adapter + Front protective cover	ZS-27-D	With M3 x 8L (2 pcs.)

Specifications

Conforms to CE marking and UL (CSA) standards.

Model		PSE30□					
Rated pressure range		-101 to 101 kPa	10 to -101 kPa	-10 to 100 kPa	-0.1 to 1 MPa	-50 to 500 kPa	-0.2 to 2.00 kPa
Power supply voltage		12 to 24 VDC ±10%, Ripple (p-p) 10% or less (with power supply polarity protection)					
Current consumption		50 mA or less (Current consumption for sensor is not included.)					
Sensor input		1 to 5 VDC (Input impedance: 1 MΩ)					
	No. of inputs	1 input					
	Input protection	With excess voltage protection (up to 26.4 V)					
Hysteresis		Hysteresis mode: Variable, Window comparator mode: Variable					
Switch output		NPN or PNP open collector output: Two outputs					
	Maximum load current	80 mA					
	Maximum load voltage	30 VDC (at NPN output)					
	Residual voltage	1 V or less (with load current of 80 mA)					
	Output protection	With short circuit protection					
Response time		1 ms or less					
	Anti-chattering function	Response time settings for anti-chattering function: 20 ms, 160 ms, 640 ms, 1280 ms					
Repeatability		±0.1%F.S. or less					
Analog output	Voltage output ^{Note 1)}	Output voltage: 1 to 5 V (within rated pressure range), Output impedance: Approx. 1 kΩ Linearity: ±0.2%F.S. (not including sensor accuracy), Response speed: 150 ms or less					
	Accuracy (to display value) (25°C)	±0.6%F.S. or less			±1.0%F.S. or less		±1.5%F.S. or less
	Current output ^{Note 1)}	Output current: 4 to 20 mA (within rated pressure range) Maximum load impedance: 300 Ω (at 12 VDC), 600 Ω (at 24 VDC), Minimum load impedance: 50 Ω Linearity: ±0.2%F.S. (not including sensor accuracy), Response time: 150 ms or less					
	Accuracy (to display value) (25°C)	±1.0%F.S. or less			±1.5%F.S. or less		±2.0%F.S. or less
Display accuracy (ambient temperature of 25°C)		±0.5%F.S. ±2 digits or less	±0.5%F.S. ±1 digit or less				
Display		3 + 1/2-digit, 7-segment indicator, 2-color display (Red/Green), Sampling frequency: 5 times/sec					
Indication light		OUT1: Lights up when ON (Green), OUT2: Lights up when ON (Red)					
Auto shift input ^{Note 1)}		Non-voltage input (reed or solid state), Low level input: 5 ms or more, Low level: 0.4 V or less					
Resistance	Enclosure	IP40					
	Operating temperature range	Operating: 0 to 50°C, Stored: -10 to 60°C (with no condensation and no freezing)					
	Operating humidity range	Operating/Stored: 35 to 85%RH (with no condensation)					
	Withstand voltage	1000 VAC for 1 minute between live parts and case					
	Insulation resistance	50 MΩ between live parts and case (at 500 VDC)					
	Vibration resistance	10 to 150 Hz at whichever is smaller of 1.5 mm amplitude or 98 m/s ² acceleration, in X, Y, Z directions, for 2 hours each (de-energized)					
	Impact resistance	100 m/s ² in X, Y, Z directions, 3 times each (de-energized)					
Temperature characteristics		±0.5%F.S. or less (based on 25°C)					
Connection		Power supply/Output connection: 5 P connector, Sensor connection: 4 P connector					
Material		Front case: PBT, Rear case: PBT					
Weight	With power supply/output connection cable	85 g					
	Without power supply/output connection cable	30 g					

Note 1) Auto shift function is not available when analogue output option is selected.

Also, analogue output option is not available when auto shift function is selected.

Note 2) The following units can be selected with unit conversion function:

For vacuum & compound pressure: kPa·kgf/cm²·bar·psi·mmHg·inHg

For positive pressure & low pressure: MPa·kPa·kgf/cm²·bar·psi

For low differential pressure: kPa·mmH₂O

Applicable pressure sensor	For compound pressure	For vacuum	For low pressure	For positive pressure		For differential pressure
	PSE533 ^{Note 4)} PSE543 PSE563	PSE531 ^{Note 4)} PSE541 PSE561	PSE532 ^{Note 4)}	PSE564	PSE530 ^{Note 4)} PSE560	-
Regulating pressure range	-101 to 101 kPa	10 to -101 kPa	-10 to 100 kPa	-50 to 500 kPa	-0.1 to 1 MPa	-0.2 to 2.00 kPa
Regulating pressure resolution	0.2 kPa	0.1 kPa	0.1 kPa	1 kPa	0.001 MPa	0.01 kPa

Note 4) Series PSE530 pressure sensors are also applicable.

Contact SMC for more information.

Internal Circuit

PSE300

NPN open collector output (2 outputs), max. 30 V or 80 mA, residual voltage 1 V or less
 Analogue output: 1 to 5 V
 Output impedance: Approx. 1 k Ω

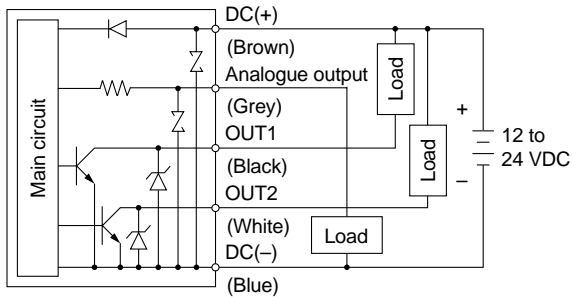

PSE303

PNP open collector output (2 outputs), max. 80 mA, residual voltage 1 V or less
 Analogue output: 1 to 5 V
 Output impedance: Approx. 1 k Ω

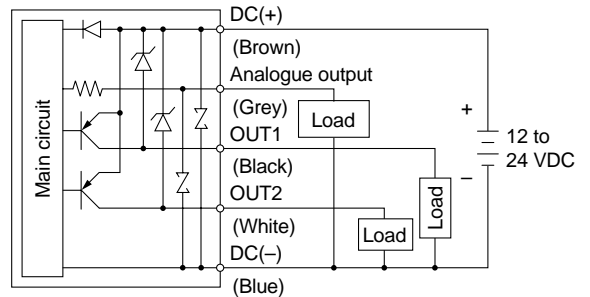

PSE301

NPN open collector output (2 outputs), max. 30 V or 80 mA, residual voltage 1 V or less
 Analogue output: 4 to 20 mA
 Maximum load impedance: 300 Ω (12 VDC), 600 Ω (24 VDC)
 Minimum load impedance: 50 Ω

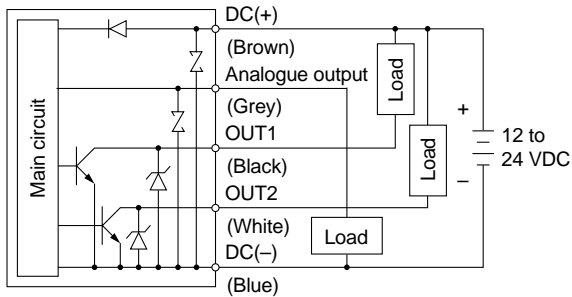

PSE304

PNP open collector output (2 outputs), max. 80 mA, residual voltage 1 V or less
 Analogue output: 4 to 20 mA
 Maximum load impedance: 300 Ω (12 VDC), 600 Ω (24 VDC)
 Minimum load impedance: 50 Ω

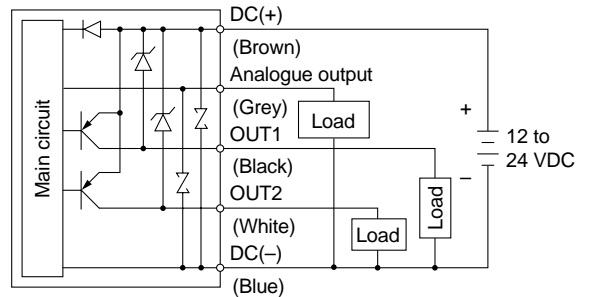

PSE302

NPN open collector output with auto shift input (2 outputs), max. 30 V or 80 mA, residual voltage 1 V or less

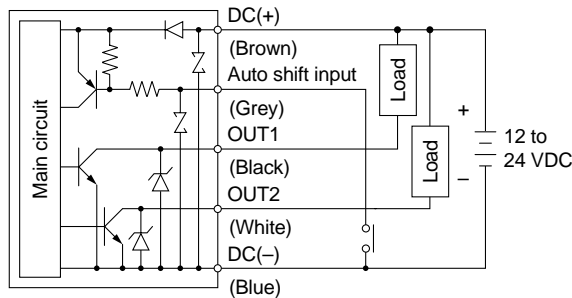

PSE305

PNP open collector output with auto shift input (2 outputs), max. 80 mA, residual voltage 1 V or less

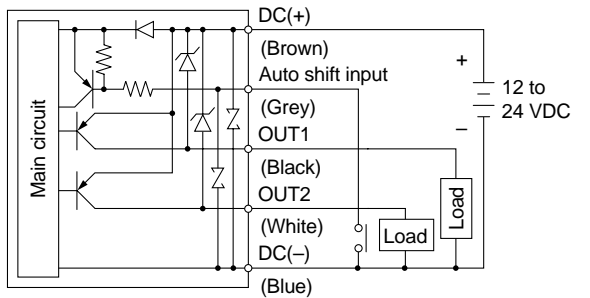

Descriptions

LCD

Displays the current pressure, set mode, selected display unit, and error code. Four different display settings are available. Always use red or green monochrome display; or switch between green and red according to the output.

Output (OUT1) Display (Green)

Lights up when OUT1 is ON.

▲ button

Use this button to select the mode or increase the ON/OFF set value. It is also used for switching to the peak display mode.

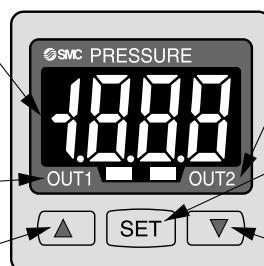

Output (OUT2) Display (Red)

Lights up when OUT2 is ON.

SET button

Use this button to change the mode or confirm the set value.

▼ button

Use this button to select the mode or decrease the ON/OFF set value. It is also used for switching to the bottom display mode.

Series PSE300

Dimensions

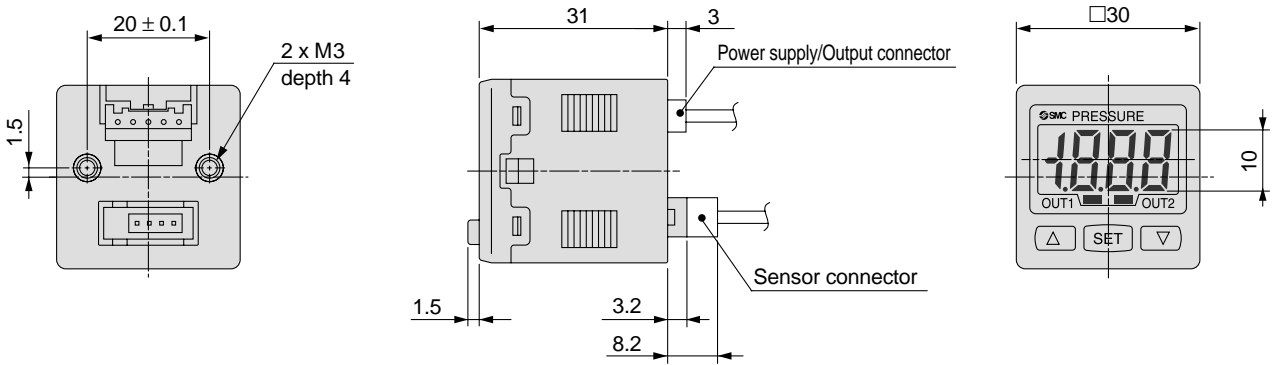

Power supply/Output connection cable (ZS-28-A)

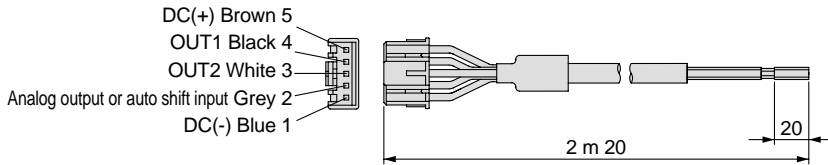

Sensor connector

PIN no.	Terminal
1	DC(+)
2	N.C.
3	DC(-)
4	IN (1 to 5 V)

With bracket

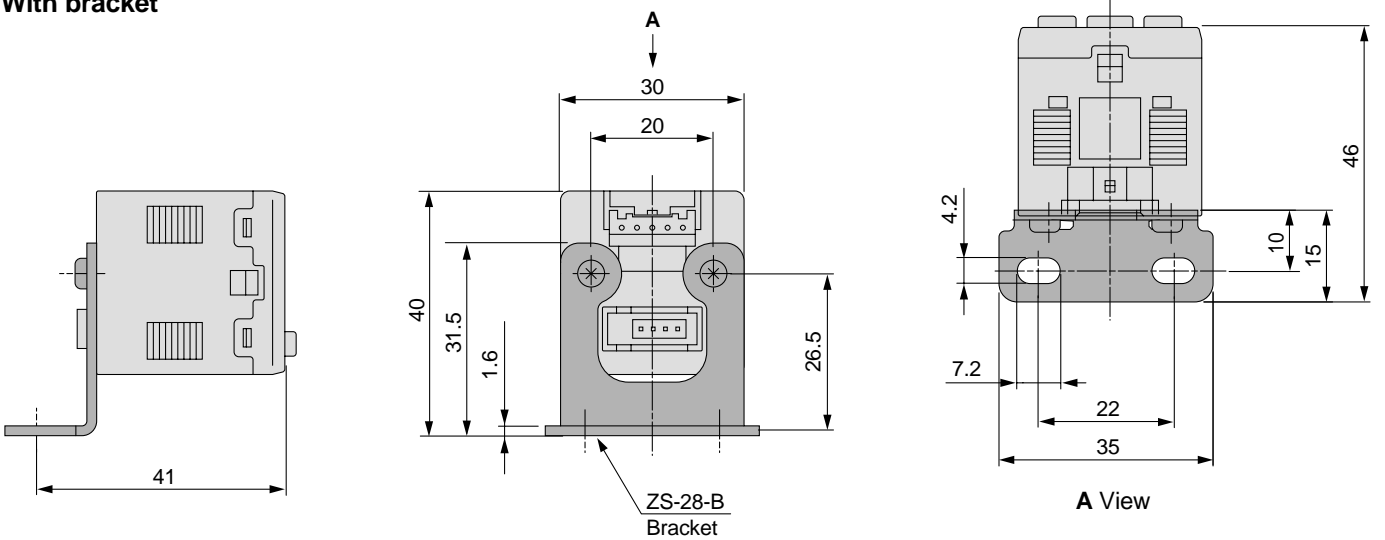

With panel mount adapter

With panel mount adapter + Front protective cover

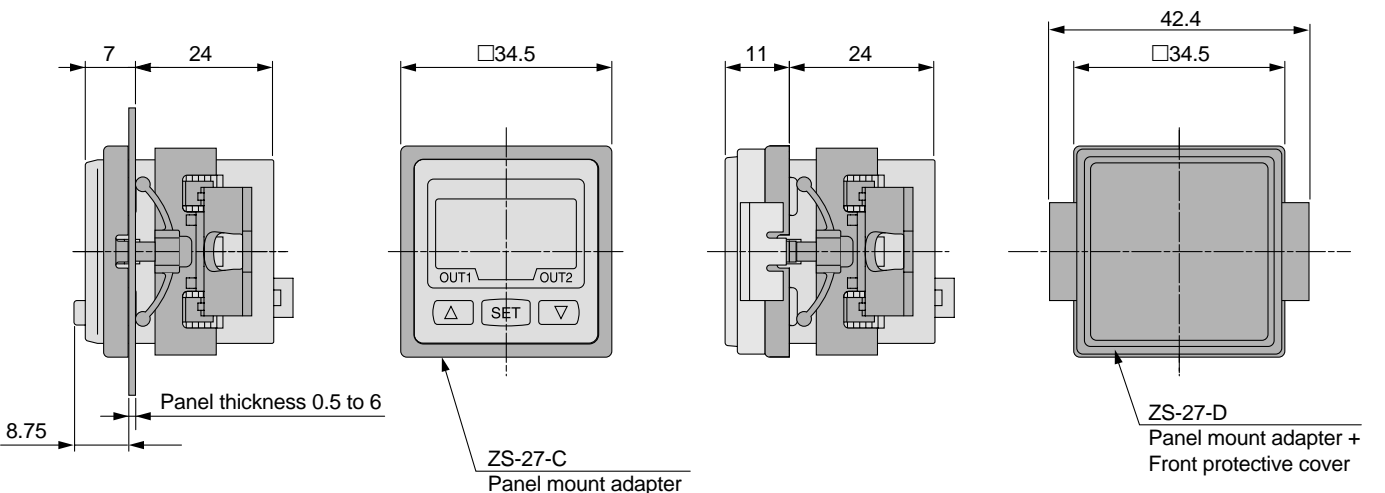

Dimensions

Panel fitting dimension

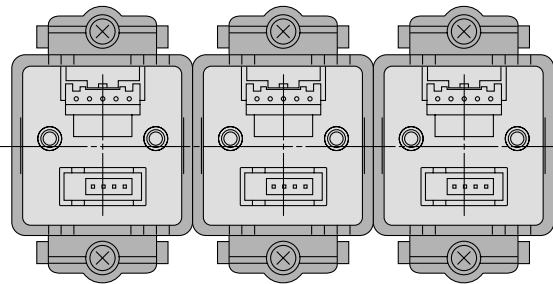
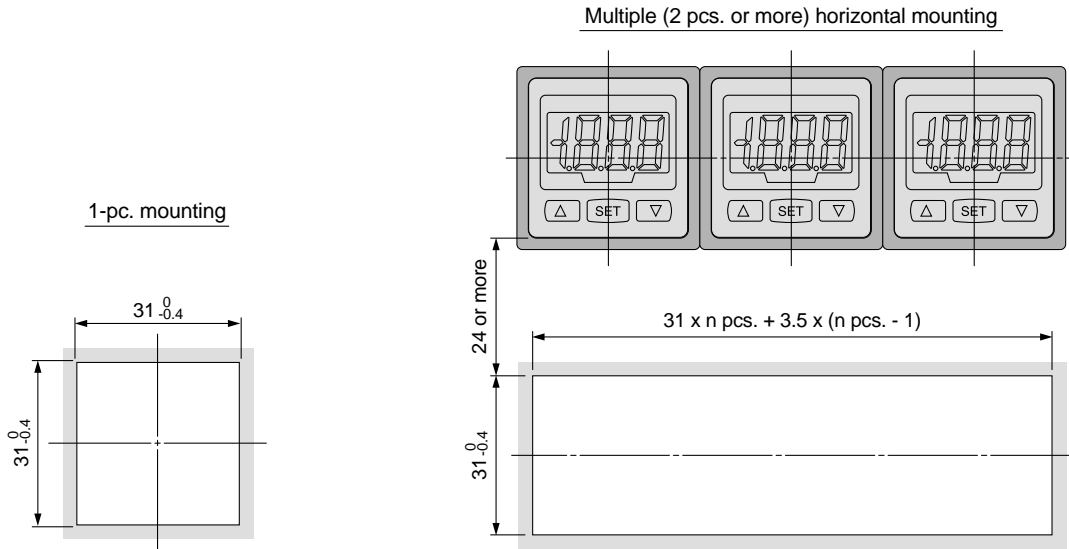

Multiple (2 pcs. or more) vertical mounting

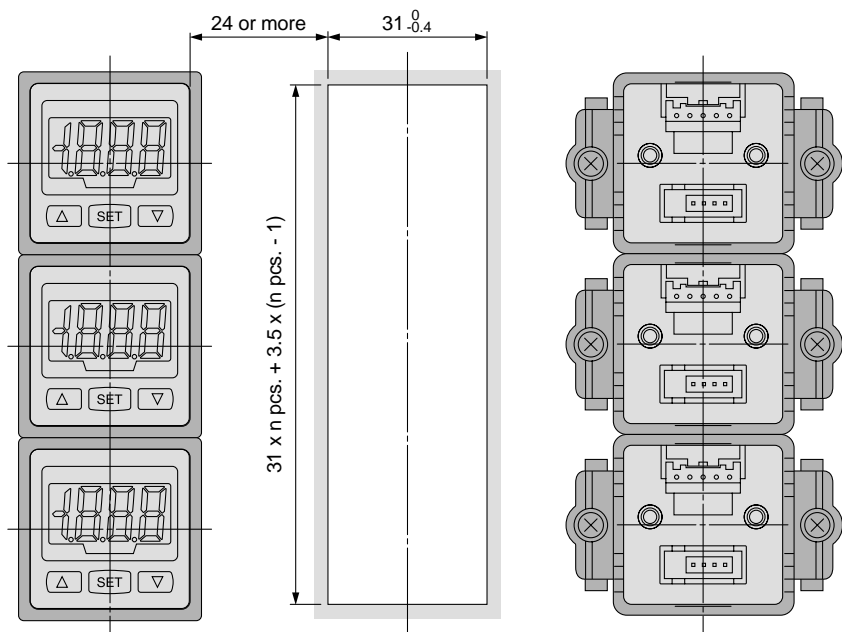

Functions

A Auto shift function

When there are large fluctuations in the supply pressure, the switch may fail to operate correctly. The auto shift function compensates such supply pressure fluctuations. It measures the pressure at the time of auto shift signal input and uses it as the reference pressure to correct the set value on the switch.

Set value correction by auto shift function

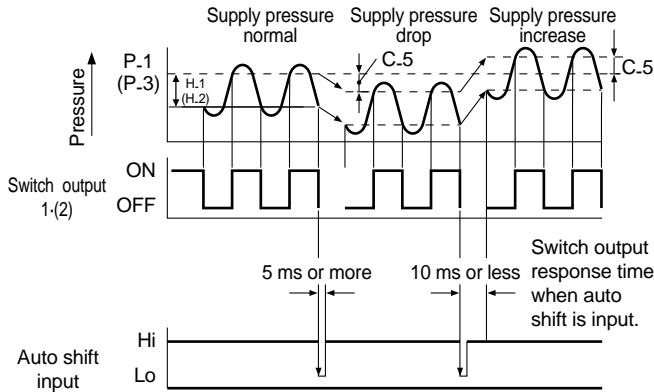

Regulating pressure ranges for auto shift input

	Rated pressure range	Regulating pressure range
Compound pressure	-101.0 to 101.0 kPa	-101.0 to 101.0 kPa
Vacuum	10.0 to -101.0 kPa	-101.0 to 101.0 kPa
Low pressure	-10 to 100.0 kPa	-100.0 to 100.0 kPa
Positive pressure	-0.1 to 1.000 MPa	-1.000 to 1.000 MPa
	-50 to 500 kPa	-500 to 500 kPa
Low differential pressure	-0.2 to 2.00 kPa	-2.00 to 2.00 kPa

B Auto preset function

Auto preset function, when selected in the initial setting, stores the set value calculated from the measured pressure. The optimum set value is determined automatically by repeating vacuum and break with the target work piece several times.

Adsorption verification

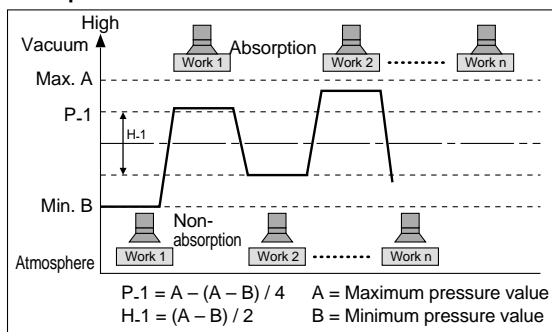

C Precision indicator setting

This function eliminates slight differences in the output values and allows uniformity in the numbers displayed. Displayed values of the pressure sensors can be adjusted to within $\pm 5\%$.

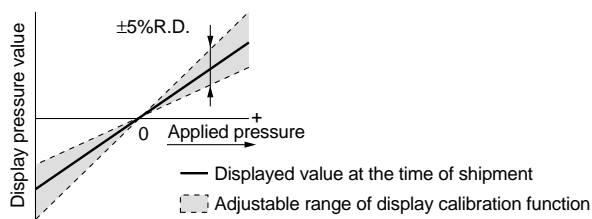

Note) When the precision indicator setting function is used, the regulating pressure value may change ± 1 digit.

D Peak and bottom display function

This function constantly detects and updates the maximum and minimum values and allows to hold the display value.

E Key lock function

This function prevents incorrect operations such as accidentally changing the set value.

F Reset function

This function clears and resets the zero value on the display within $\pm 7\%$ F.S. of the factory adjusted value.

G Error indication function

Error name	Error code	Description
Overcurrent error	OUT1	Er1
	OUT2	Er2
Residual pressure error		Er3
Applied pressure error		HHH
		LLL
Auto shift error		or
System error		Er4
		Er6
		Er7
		Er8

H Unit display switching function

Display units can be switched with this function. Units that can be displayed vary depending on the range of the pressure sensors connected to the controller.

Pressure range	For compound pressure	For vacuum	For low pressure	For positive pressure	For low differential pressure	
Applicable pressure sensor	PSE533 PSE543 PSE563	PSE531 PSE541 PSE561	PSE532	PSE530 PSE560	PSE564	
Rated pressure range	-101 to 101 kPa	10 to -101 kPa	-10 to 100 kPa	-0.1 to 1 MPa	-50 to 500 kPa	-0.2 to 2.00 kPa
PA	kPa	0.2	0.1	0.1	1	0.01
	MPa	-	-	-	0.001	-
GF	kgf/cm ²	0.002	0.001	0.001	0.01	-
bAr	bar	0.002	0.001	0.001	0.01	-
PSI	psi	0.05	0.02	0.02	0.2	-
inh	inHg	0.1	0.1	-	-	-
mmH	mmHg	2	1	-	-	1 mmH ₂ O

Functions

1 Anti-chattering function

A large bore cylinder or ejector consumes a large volume of air in operation and may experience a temporary drop in the supply pressure. This function prevents detection of such temporary drops in the supply pressure as an error.

Response time settings: 20 ms, 160 ms, 640 ms, 1280 ms

<Principle>

This function averages pressure values measured during the response time set by the user and then compares the average pressure value with the pressure set point value to output the result on the switch.

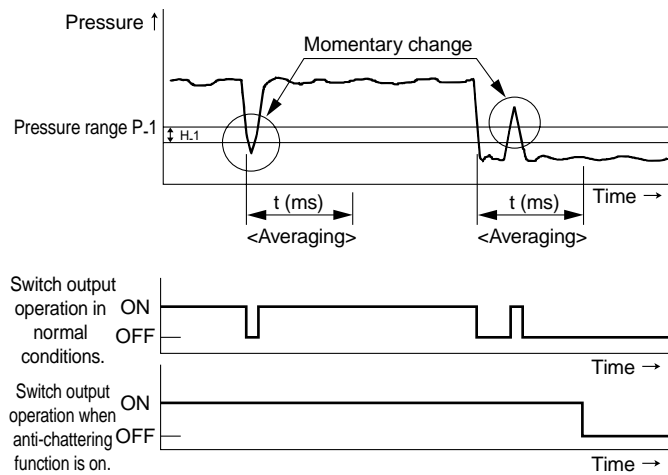



Series PSE

Safety Instructions

These safety instructions are intended to prevent a hazardous situation and/or equipment damage. These instructions indicate the level of potential hazard by a label of "**Caution**", "**Warning**" or "**Danger**". To ensure safety, be sure to observe ISO 4414 Note 1), JIS B 8370 Note 2) and other safety practices.

⚠ Caution : Operator error could result in injury or equipment damage.

⚠ Warning : Operator error could result in serious injury or loss of life.

⚠ Danger : In extreme conditions, there is a possible result of serious injury or loss of life.

Note 1) ISO 4414: Pneumatic fluid power – General Rules for Pneumatic Equipment

Note 2) JIS B 8370: Pneumatic system axiom

⚠ Warning

1. The compatibility of pneumatic equipment is the responsibility of the person who designs the pneumatic system or decides its specifications.

Since the products specified here are used in various operating conditions, their compatibility with the specific pneumatic system must be based on specifications or after analysis and/or tests to meet your specific requirements. The expected performance and safety assurance will be the responsibility of the person who has determined the compatibility of the system. This person should continuously review the suitability of all items specified, referring to the latest catalogue information with a view to giving due consideration to any possibility of equipment failure when configuring a system.

2. Only trained personnel should operate pneumatically operated machinery and equipment.

Compressed air can be dangerous if handled incorrectly. Assembly, handling or maintenance of pneumatic systems should be performed by trained and experienced operators.

3. Do not service machinery/equipment or attempt to remove components until safety is confirmed.

1. Inspection and maintenance of machinery/equipment should only be performed after confirmation of safe locked-out control positions.
2. When equipment is to be removed, confirm the safety process as mentioned above. Cut the supply pressure for this equipment and exhaust all residual compressed air in the system.
3. Before machinery/equipment is restarted, take measures to prevent shooting-out of cylinder piston rod, etc. (Bleed air into the system gradually to create back pressure.)

4. Contact SMC if the product is to be used in any of the following conditions:

1. Conditions and environments beyond the given specifications, or if product is used outdoors.
2. Installation on equipment in conjunction with atomic energy, railway, air navigation, vehicles, medical equipment, food and beverages, recreation equipment, emergency stop circuits, press applications, or safety equipment.
3. An application which has the possibility of having negative effects on people, property, or animals, and therefore requires special safety analysis.



Pressure Switch Precautions 1

Be sure to read before handling. Refer to pages 13 through 15 for general safety instructions and common precautions, and to pages 16 through 18 for specific product precautions.

Design & Selection

Warning

1. Operate the switch only within the specified voltage.

Use of the switch outside the range of the specified voltage can cause not only malfunction and damage of the switch but also electrocution and fire.

2. Do not exceed the maximum allowable load specification.

A load exceeding the maximum load specification can cause damage to the switch or shorten its service life.

3. Do not use a load that generates surge voltage.

Although surge protection is installed in the circuit at the output side of the switch, damage may still occur if a surge is applied repeatedly. When a surge generating a load such as a relay or solenoid is directly driven, use a type of switch with a built-in surge absorbing element.

4. Since the type of fluid varies depending on the product, be sure to verify the specifications.

The switches do not have an explosion proof rating. To prevent a possible fire hazard, do not use with flammable gases or fluids.

5. Operate the switch within the regulating pressure range and maximum operating pressure.

Malfunction can occur if the pressure sensor is used outside the specified pressure range, and the sensor may be permanently damaged if used at a pressure that is above the maximum operating pressure.

Mounting

Warning

1. If the equipment is not operating properly, do not continue to use it.

Connect air and power after installation, repairs, or modifications, and verify proper installation. The switch should be checked for proper operation and possible leaks.

2. Mount switches using the proper tightening torque.

When a switch is tightened beyond the specified tightening torque, the mounting screws, mounting bracket, or switch may be damaged. On the other hand, tightening below the specified tightening torque may cause the installation screws to come loose during operation.

Nominal thread size	Tightening torque (N·m)
M3	1/4 rotation after tightening by hand
M5	1/6 rotation after tightening by hand
R-NPT-Rc1/8	7 to 9
R-NPT1/4	12 to 14

Mounting

Warning

3. Apply wrench only to the metal part of the main housing that is integrated with the piping when installing the pressure switch onto the system piping.

Do not apply a wrench to the resin part as this may damage the switch.

Wiring

Warning

1. Verify the colour and terminal number when wiring.

Incorrect wiring can cause the switch to be damaged and malfunction. Verify the colour and the terminal number in the instruction manual when wiring.

2. Avoid repeatedly bending or stretching the lead wire.

Repeatedly applying bending stress or stretching force to the lead wire will cause it to break. If you believe the lead wire is damaged and likely to cause malfunctions, replace it.

3. Confirm proper insulation of wiring.

Make sure that there is no faulty wiring insulation (contact with other circuits, ground fault, improper insulation between terminals, etc.). Damage may occur due to excess current flow into a switch.

Operating Environment

Warning

1. Never use in an atmosphere of explosive gases.

The switches do not have an explosion proof rating. Never use in the pressure of an explosive gas as this may cause a serious explosion.

Maintenance

Warning

1. Perform a periodical inspections for proper operation of the switch.

Unexpected malfunction or erroneous operation may lead to failure in ensuring safety.

2. Take precautions when using the switch for an interlock circuit.

When a pressure switch is used for an interlock circuit, devise a multiple interlock system to avoid trouble. Verify the operation of the switch and interlock function on a regular basis so that they operate properly.



Digital Pressure Switch Precautions 2

Be sure to read before handling. Refer to pages 13 through 15 for general safety instructions and common precautions, and to pages 16 through 18 for specific product precautions.

Selection

⚠ Warning

1. Monitor the internal voltage drop of the switch.

When operating below the specified voltage, it is possible that the load may be ineffective even though the pressure switch function is normal. Therefore, the formula below should be satisfied after confirming the minimum operating voltage of the load.

$$\text{Supply voltage} - \text{Internal voltage drop of switch} > \text{Minimum operating voltage of load}$$

⚠ Caution

1. Data of the controller (Pressure sensor) will be stored even after the power is turned off.

Input data (set pressure, etc.) will be stored in EEPROM so that the data will not be lost after the pressure switch is turned off. (Data will be stored for up to 100,000 hours after the power is turned off.)

Mounting

⚠ Warning

1. Operation

Refer to the instruction manual for the button operation of the digital pressure switch.

2. Do not touch the LCD indicator.

Do not touch the LCD indicator face of the pressure switch during operation. Static electricity can change the readout.

3. Pressure port

Do not introduce wire, needles, or similar objects to the pressure port as this may damage the pressure sensor and cause malfunctions.

Wiring

⚠ Warning

1. Do not wire in conjunction with power lines or high voltage lines.

Wire separately from power lines and high voltage lines, avoiding wiring in the same conduit with these lines. Control circuits including switches may malfunction due to noise from these other lines.

2. Do not allow loads to short circuit.

(3-wire type)

Although digital pressure switches indicate overcurrent error if loads are short circuited, not all incorrect wiring connections can be protected. Take precautions to avoid incorrect wiring.

As for other pressure switches, the switches will be instantly damaged if loads are short circuited. Take special care to avoid reverse wiring between the brown power supply line and the black output line on 3-wire type switches.

3. Connect a DC(-) wire (blue) as close as possible to the DC power supply GND terminal.

Connecting the power supply away from the GND terminal can cause malfunctions due to noise from devices that are connected to the GND terminal.

Air supply

⚠ Warning

1. Use the switch within the specified fluid and ambient temperature range.

Ambient and fluid temperature range is as follows:

Digital pressure switches: 0° to 50°C

Other pressure switches: 0° to 60°C

Take measures to prevent freezing of moisture in circuits below 5°C, since this may cause damage to the O-ring and lead to malfunction. The installation of an air dryer is recommended for eliminating condensate and moisture. Never use the switch in an environment where there are drastic temperature changes even when these temperatures are within the specified temperature range.

2. Vacuum switch

An instant pressure pulse of up to 0.5 MPa (at the time of vacuum release) will not affect the performance of the switch. However, a constant pressure of 0.2 MPa or more should be avoided.

Operating Environment

⚠ Warning

1. Do not use in an area where surges are generated.

When there are units that generate a large amount of surge in the area around pressure switches, (e.g., solenoid type lifters, high frequency induction furnaces, motors) this may cause deterioration or damage to the switch's internal circuitry. Avoid sources of surge generation and crossed lines.

2. Operating environment

In general, the digital pressure switches featured here are not dust or splash proof. Avoid using in an environment where the likelihood of splashing or spraying of liquids exists. If used in such an environment, use a dustproof and splash proof type switch.

Maintenance

⚠ Caution

1. Cleaning of the switch body

Wipe off dirt with a soft cloth. If dirt does not come off easily, use a neutral detergent diluted with water to dampen the soft cloth. Wipe the switch only after squeezing the excess water out of the dampened cloth. Then finish off by wiping with a dry cloth.



Series PSE

Specific Product Precautions 1

Be sure to read before handling. Refer to pages 13 through 15 for general safety instructions and common precautions, and to pages 16 through 18 for specific product precautions.

Pressure Sensor

Handling

Warning

1. Do not drop, bump, or apply excessive impact (PSE540: 980 m/s², PSE560: 500 m/s²) while handling. Although the body of the sensor may not be damaged, the inside of the sensor could be damaged and lead to malfunction.
2. The tensile strength of the cord is 50 N. Applying a greater pulling force to it can cause malfunction. When handling, hold the body of the sensor – do not dangle it from the cord.
3. Do not use pressure sensors with corrosive and/or flammable gases or liquids.

4. Connection of sensor connector

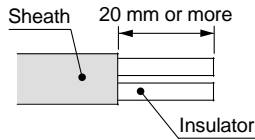

- Cut the sensor cable as illustrated to the right.
- Referring to the table below, insert each lead wire of the cable at the position marked with a number corresponding to the colour of the lead wire.

Connector no.	Wire core colour	
	For PSE200 (ZS-26-E)	For PSE300 (ZS-28-C)
1	Brown (DC(+))	Brown (DC(+))
2	Black (OUT: 1 to 5 V)	Not connected
3	Blue (DC(-))	Blue (DC(-))
4	Not connected	Black (OUT: 1 to 5 V)

- Confirm that the numbers on the connector match the colours of the wires and that the wires are inserted to the bottom. Press Part A by hand for temporary fixing.

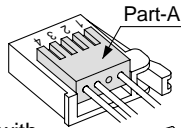

- Press in the central part of Part A vertically with a tool such as pliers.

- A sensor connector cannot be taken apart for reuse once it is crimped. If the wire arrangement is incorrect or if the wire insertion fails, use a new sensor connector.

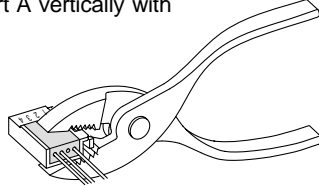

- For connection to SMC Series PSE300 pressure switches, use sensor connectors (ZS-28-C) or e-con connectors listed below.

Manufacturer	Part No.
Sumitomo 3M	37104-3101-000FL
Tyco Electronics AMP	1-1473562-4

- For detailed information about e-con connectors, please consult the manufacturers of the respective connectors.

Operating Environment

Warning

1. The pressure sensors are CE marked; however, they are not equipped with surge protection against lightning. Lightning surge countermeasures should be applied directly to system components as necessary.
2. The pressure sensors do not have an explosion proof rating. Never use pressure sensors in the presence of flammable or explosive gases.

Air Supply

Warning

① Use of toxic, corrosive or flammable gases

Since the switch uses SUS316L as the material of the pressure sensor and fittings, do not use toxic or corrosive gases.

② Fluid compatibility

Since the switch uses SUS316L as the wetted material (for the pressure sensor and fittings), use fluids that will not corrode this material.

(For the corrosiveness of the fluids, please consult the manufacturers of the respective fluids.)

Helium leakage test

Helium leakage test is conducted on the welded parts. Use ferrules by Crawford Fittings (Swagelok® fittings) as TSJ fittings, seals and glands by Cajon (VCR® fittings) as URJ fittings. If ferrules, seals, or glands of other brands are to be used, be sure to conduct helium leakage test before these products are used.

Controller

Handling

Warning

1. Do not drop, bump, or apply excessive impact (100 m/s²) while handling. Although the body of the controller case may not be damaged, the inside of the controller could be damaged and cause malfunction.
2. The tensile strength of the power supply/output connection cable is 50 N; that of the pressure sensor lead wire with connector is 25 N. Applying a greater pulling force than the applicable specified tensile strength to either of these components can lead to malfunction. When handling, hold the body of the controller – do not dangle it from the cord.

Connection

Warning

1. Incorrect wiring can damage the switch and cause malfunction or erroneous switch output. Connections should be done while the power is turned off.
2. Do not attempt to insert or pull out the pressure sensor or its connector when the power is on. Switch output may malfunction.
3. Wire separately from power lines and high voltage lines, avoiding wiring in the same conduit with these lines. Malfunctions may occur due to noise from these other lines.
4. If a commercial switching regulator is used, make sure that the F.G. terminal is grounded.



Series PSE Specific Product Precautions 2

Be sure to read before handling. Refer to pages 13 through 15 for general safety instructions and common precautions, and to pages 16 through 18 for specific product precautions.

Controller

Operating Environment

Warning

1. Our pressure sensor controllers are CE marked; however, they are not equipped with surge protection against lightning. Lightning surge countermeasures should be applied directly to system components as necessary.
2. Our pressure sensor controllers do not have an explosion proof rating. Never use pressure sensors in the presence of flammable or explosive gases.
3. Enclosure "IP65" applies only to the front face of the panel when mounting. Do not use in an environment where oil splashing or spraying is anticipated.

Mounting

Caution

① Mounting with bracket

Mount the bracket on the body with two M3 x 5L mounting screws.

Tighten the bracket mounting screws at a tightening torque of 0.5 to 0.7 N-m.

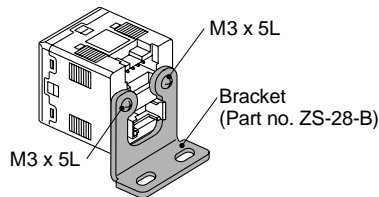

② Mounting with panel mount adapter

Secure the panel mount adapter with two M3 x 8L mounting screws.

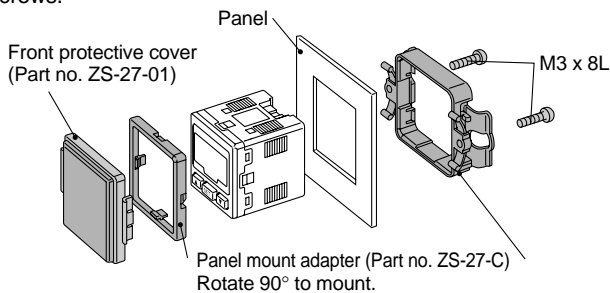

Mounting

Caution

② Panel mount adapter removal

To remove the controller with panel mount adapter from the equipment, remove the two mounting screws, and pull out the controller while pushing the claws outward.

Failure to follow this procedure can cause damage to the controller and panel mount adapter.

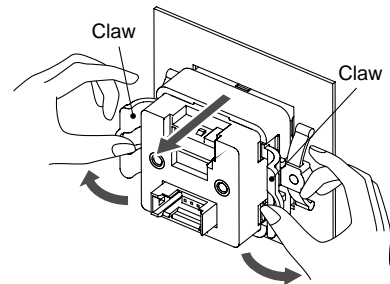

Wiring

Caution

① Connection and removal of sensor connector

- Hold the lever and connector body with two fingers and insert the connector straight into the pin until it is locked with a click sound.

- To remove the connector, pull it out straight while pressing the lever with one finger.

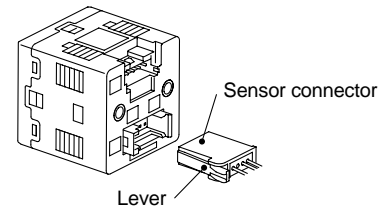

② Connector pin numbers for power supply/output cable

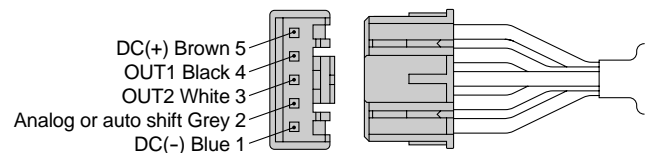



Series PSE Specific Product Precautions 3

Be sure to read before handling. Refer to pages 13 through 15 for general safety instructions and common precautions, and to pages 16 through 18 for specific product precautions.

Regulating pressure range and rated pressure range

⚠ Caution

Set the pressure within the rated pressure range.

The regulating pressure range is the range of pressure that can be set on the controller.

The rated pressure range is the range of pressure that satisfies the specifications (accuracy, linearity, etc.) of the sensor.

Although it is possible to set a value outside the rated pressure range, the specifications will not be guaranteed even if the value stays within the regulating pressure range.

Sensor		Pressure range				
		-100 kPa	0	100 kPa	500 kPa	1 MPa
For vacuum	PSE541	-101 kPa	0 kPa			
	PSE561	-101 kPa	10 kPa			
For compound pressure	PSE543	-100 kPa	100 kPa			
	PSE563	-101 kPa	101 kPa			
For positive pressure	PSE560	-100 kPa (-0.1 MPa)	0			1 MPa
	PSE564		0	500 kPa		

Rated pressure range of sensor
 Regulating pressure range of controller

EUROPEAN SUBSIDIARIES:

Austria

SMC Pneumatik GmbH (Austria).
Girakstrasse 8, A-2100 Korneuburg
Phone: +43 2262-62280, Fax: +43 2262-62285
E-mail: office@smc.at
http://www.smc.at

Germany

SMC Pneumatik GmbH
Boschring 13-15, D-63329 Egelsbach
Phone: 06103-4020, Fax: 06103-402139
E-mail: info@smc-pneumatik.de
http://www.smc-pneumatik.de

Netherlands

SMC Pneumatics BV
De Ruyterkade 120, NL-1011 AB Amsterdam
Phone: 020-5318888, Fax: 020-5318880
E-mail: info@smcpneumatics.nl

Slovenia

SMC industrijska Avtomatika d.o.o.
Grajski trg 15, SLO-8360 Zuzemberk
Phone: +386 738 85240 Fax: +386 738 85249
E-mail: office@smc-ind-avtom.si
http://www.smc-ind-avtom.si

Belgium

SMC Pneumatics N.V./S.A.
Nijverheidsstraat 20, B-2160 Wommelgem
Phone: 03-355-1464, Fax: 03-355-1466
E-mail: post@smcpneumatics.be

Greece

S. Parianopoulos S.A.
7, Konstantinoupoleos Street,
GR-11855 Athens
Phone: 01-3426076, Fax: 01-3455578

Norway

SMC Pneumatics Norway A/S
Vollsveien 13 C, Granfos Næringspark
N-1366 Lysaker
Tel: (47) 67 12 90 20, Fax: (47) 67 12 90 21
http://www.smc-norge.no

Spain

SMC España, S.A.
Zuazobidea 14
01015 Vitoria
Phone: 945-184 100, Fax: 945-184 124
E-mail: post@smc.smces.es

Czech Republic

SMC Industrial Automation CZ s.r.o.
Hudcova 78a, CZ-61200 Brno
Phone: +420 5 414 24611, Fax: +420 5 412 18034
E-mail: office@smc.cz
http://www.smc.cz

Hungary

SMC Hungary Ipari Automatizálási Kft.
Budafoki út 107-113, H-1117 Budapest
Phone: +36 1 371 1343, Fax: +36 1 371 1344
E-mail: office@smc-automation.hu
http://www.smc-automation.hu

Poland

SMC Industrial Automation Polska Sp.z.o.o.
ul. Konstruktorska 11A, PL-02-673 Warszawa.
Phone: +48 22 548 5085, Fax: +48 22 548 5087
E-mail: office@smc.pl
http://www.smc.pl

Sweden

SMC Pneumatics Sweden AB
Ekhagsvägen 29-31, S-141 71 Huddinge
Phone: 08-603 07 00, Fax: 08-603 07 10
http://www.smc.nu

Denmark

SMC Pneumatik A/S
Knudsminde 4B, DK-8300 Odder
Phone: (45)70252900, Fax: (45)70252901
E-mail: smc@smc-pneumatik.dk

Ireland

SMC Pneumatics (Ireland) Ltd.
2002 Citywest Business Campus,
Naas Road, Saggart, Co. Dublin
Phone: 01-403 9000, Fax: 01-464-0500

Portugal

SMC Sucursal Portugal, S.A.
Rua de Engº Ferreira Dias 452, 4100-246 Porto
Phone: 22-610-89-22, Fax: 22-610-89-36
E-mail: postpt@smc.smces.es

Switzerland

SMC Pneumatik AG
Dorfstrasse 7, CH-8484 Weisslingen
Phone: 052-396-3131, Fax: 052-396-3191
E-mail: info@smc.ch
http://www.smc.ch

Estonia

SMC Pneumatics Estonia OÜ
Laki 12-101, 106 21 Tallinn
Phone: 06 593540, Fax: 06 593541
http://www.smcpcneumatics.ee

Italy

SMC Italia S.p.A
Via Garibaldi 62, I-20061 Carugate, (Milano)
Phone: 02-92711, Fax: 02-9271365
E-mail: mailbox@smcitalia.it
http://www.smcitalia.it

Romania

SMC Romania srl
Str. Frunzei 29, Sector 2, Bucharest
Phone: 01-324-2626, Fax: 01-324-2627
E-mail: smccadm@canad.ro
http://www.smcromania.ro

Turkey

Entek Pnömatik San. ve Tic Ltd. Sti.
Perpa Tic. Merkezi Kat: 11 No: 1625,
TR-80270 Okmeydanı Istanbul
Phone: 0212-221-1512, Fax: 0212-221-1519
http://www.entek.com.tr

Finland

SMC Pneumatics Finland OY
PL72, Tiistiniityntie 4, SF-02031 ESPOO
Phone: 09-859 580, Fax: 09-8595 8595
http://www.smcfitec.sci.fi

Latvia

SMC Pneumatics Latvia SIA
Smerla 1-705, Riga LV-1006, Latvia
Phone: 0777-94-74, Fax: 0777-94-75
http://www.smc.lv

Russia

SMC Pneumatik LLC.
36/40 Sredny pr. St. Petersburg 199004
Phone: (812) 118 5445, Fax: (812) 118 5449
E-mail: smcfa@peterlink.ru
http://www.smc-pneumatik.ru

UK

SMC Pneumatics (UK) Ltd
Vincent Avenue, Crownhill,
Milton Keynes, MK8 0AN
Phone: 0800 1382930 Fax: 01908-555064
E-mail: sales@smcpneumatics.co.uk
http://www.smcpcneumatics.co.uk

France

SMC Pneumatique, S.A.
1, Boulevard de Strasbourg, Parc Gustave Eiffel
Bussy Saint Georges
F-77607 Marne La Vallée Cedex 3
Phone: 01-6476 1000, Fax: 01-6476 1010
http://www.smc-france.fr

Lithuania

UAB Ottensten Lietuva
Savanoriu pr. 180, LT-2600 Vilnius, Lithuania
Phone/Fax: 370-2651602

Slovakia

SMC Priemyselná Automatizácia, s.r.o.
Námestie Martina Benku 10
SK-81107 Bratislava
Phone: +421 2 444 56725, Fax: +421 2 444 56028
E-mail: office@smc.sk
http://www.smc.sk

OTHER SUBSIDIARIES WORLDWIDE:

ARGENTINA, AUSTRALIA, BOLIVIA, BRASIL, CANADA, CHILE, CHINA, HONG KONG, INDIA, MALAYSIA, MEXICO, NEW ZEALAND, PHILIPPINES, SINGAPORE, SOUTH KOREA, TAIWAN, THAILAND, USA, VENEZUELA



<http://www.smceu.com>
<http://www.smcworld.com>