

# Electro-Pneumatic Regulator

Stepless control of air pressure proportional to an electrical signal

ITV1000  
200 ℓ/min (ANR)\*

ITV2000  
1500 ℓ/min (ANR)\*

ITV3000  
4000 ℓ/min (ANR)\*

200 ℓ/min type is newly  
introduced to the series.  
Oil free specifications (wetted parts)



Series *ITV1000/2000/3000*

\* Pressure range: 0.9 MPa, Supply pressure: 1.0 MPa

Sensitivity: **0.2 kPa** (100 kPa specifications)

IP65

Linearity: Within **±1%** (F.S.)

Hysteresis: Within **±0.5%** (F.S.)

# Electro-Pneumatic Regulator

## Series *ITV1000/2000/3000*

### Standard Specifications



Straight type



Right angle type

#### JIS Symbol

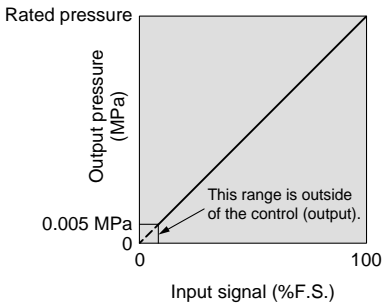
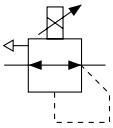

Input/output characteristics chart

Model		ITV101□	ITV103□	ITV105□
		ITV201□	ITV203□	ITV205□
		ITV301□	ITV303□	ITV305□
Minimum supply pressure		Set pressure +0.1 MPa		
Maximum supply pressure		0.2 MPa		1.0 MPa
Set pressure range		Note 1) 0.005 to 0.1 MPa   0.005 to 0.5 MPa   0.005 to 0.9 MPa		
Power supply	Voltage	24 VDC ± 10%, 12 to 15 VDC		
	Current consumption	Power supply voltage 24 VDC type: 0.12 A or less Power supply voltage 12 to 15 VDC type: 0.18 A or less		
Input signal	Current type	Note 2) 4 to 20 mA, 0 to 20 mA (Sink type)		
	Voltage type	0 to 5 VDC, 0 to 10 VDC		
	Preset input	4 points		
Input impedance	Current type	250 Ω or less		
	Voltage type	Approx. 6.5 kΩ		
	Preset input	Approx. 2.7 kΩ		
Output signal (monitor output)	Analogue output	Note 3) 1 to 5 VDC (Load impedance: 1 kΩ or more)		
	Switch output	NPN open collector output: Max. 30 V, 30 mA PNP open collector output: Max. 30 mA		
Linearity		Within ±1% (full span)		
Hysteresis		Within 0.5% (full span)		
Repeatability		Within ±0.5% (full span)		
Sensitivity		Within 0.2% (full span)		
Temperature characteristics		Within ±0.12% (full span)/°C		
Output pressure display	Accuracy	±3% (full span)		
	Minimum unit	MPa: 0.01, kgf/cm <sup>2</sup> : 0.01, bar: 0.01, PSI: 0.1 Note 4), kPa: 1		
Ambient and fluid temperature		0 to 50°C (with no condensation)		
Enclosure		IP65		
Weight	ITV10□□	Approx. 250 g (without options)		
	ITV20□□	Approx. 350 g (without options)		
	ITV30□□	Approx. 645 g (without options)		

- Note 1) Please refer to graph 1, relation to the differences between the set pressure and input. Additionally, refer to the page 18 for the set pressure range by units of standard measured pressure. Additionally, refer to page 18 as maximum set pressure differs on unit of standard measure.
- Note 2) 2-wire type 4 to 20 mA is not available. Power supply voltage (24 VDC or 12 to 15 VDC) is required.
- Note 3) Select either analogue output or switch output. Further, when switch output is selected, select either NPN output or PNP output.
- Note 4) The minimum unit for ITV205□ is 1PSI.
- Note 5) The above characteristics are confined to the static state. When air is consumed on the output side, the pressure may fluctuate.

### How to Order

**ITV 3 0 1 0 - 0 1 2 S - Q**

**Model**

1	1000
2	2000
3	3000

**Pressure range**

1	0.1 MPa
3	0.5 MPa
5	0.9 MPa

**Power supply voltage**

0	24 VDC
1	12 to 15 VDC

**Input signal**

0	Current 4 to 20 mA (Sink type)
1	Current 0 to 20 mA (Sink type)
2	Voltage 0 to 5 VDC
3	Voltage 0 to 10 VDC
4*	Preset input

\* Option

**Monitor output**

0*	None (for preset input)
1	Analogue output 1 to 5V DC
2*	Switch output/NPN output
3*	Switch output/PNP output

\* Option

**Thread type**

-	Rc
N*	NPT
T*	NPTF
F*	G

\* Option

**Port size**

1	1/8 (1000 type)
2	1/4 (1000, 2000, 3000 type)
3	3/8 (2000, 3000 type)
4	1/2 (3000 type)

**Pressure display unit**

-	MPa
2	kgf/cm <sup>2</sup>
3	bar
4	PSI
5	kPa

**CE compliance**

Q	CE compliant
---	--------------

**Cable connector type**

S	Straight type 3 m
L*	Right angle type 3 m
N*	Without cable connector

\* Option

**Bracket**

-	Without bracket
B*	Flat bracket
C*	L-bracket

\* Option

# Electro-Pneumatic Regulator *Series ITV1000/2000/3000*

## Combinations

○ Standard specifications    ◯ Combination possible    ◻ Combination not possible

\* ITV10□□ models are not applicable.

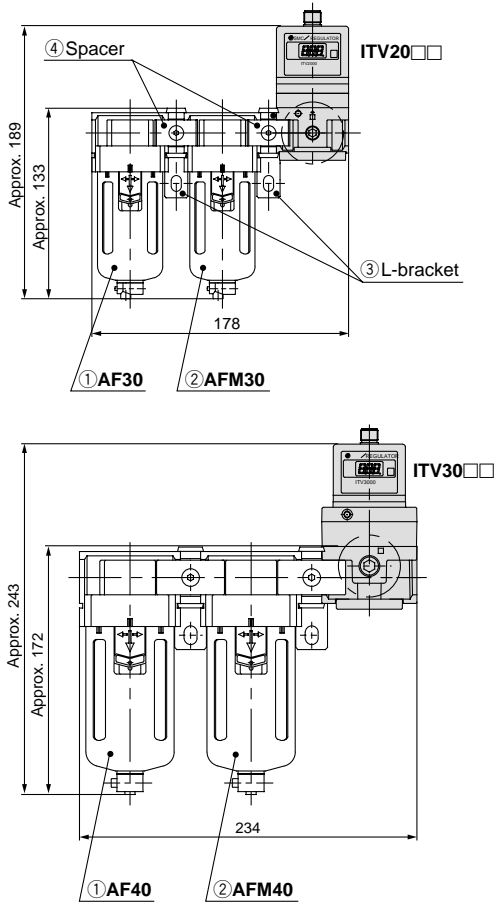

Specifications		Symbol	Applicable model	
			ITV20□□	ITV30□□
Standard specifications	Set pressure max. 0.1 MPa	1	○	○
	Set pressure max. 0.5 MPa	3	○	○
	Set pressure max. 0.9 MPa	5	○	○
	Connection Rc 1/4	02	○	○
	Connection Rc 3/8	03	○	○
	Connection Rc 1/2	04	◻	○
Accessories	Bracket	B	○	○
	Bracket	C	○	○
Optional specifications	Connection NPT1/4	N02	○	○
	Connection NPT3/8	N03	○	○
	Connection NPT1/2	N04	◻	○
	Connection G 1/4	F02	○	○
	Connection G 3/8	F03	○	○
	Connection G 1/2	F04	◻	○

## Modular Products and Accessory Combinations

\* ITV10□□ models are not applicable.

Applicable products and accessories	Applicable model	
	ITV20□□	ITV30□□
① Air filter	AF30	AF40
② Mist separator	AFM30	AFM40
③ L-bracket	B310L	B410L
④ Spacer	Y30	Y40
⑤ Spacer with L-bracket (③ + ④)	Y30L	Y40L

## Accessories (Optional)/Part Numbers

Description	Part No.		
	ITV10□□	ITV20□□	ITV30□□
Flat bracket	P3020114 (Mounting screws not included.)		
L-bracket	INI-398-0-6 (Mounting screws not included.)		
Cable connector (Note1)	Straight type 3 m	P398010-12	
	Right angle type 3 m	P398010-13	

Note 1) For CE marked ITV products, the recommended cable connector is with ferrite core fitted, as the above proposed.

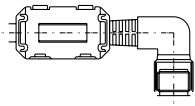
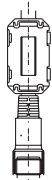
Right angle type	Straight type
P398010-13	P398010-12
	

### Dimensions

#### Flat bracket

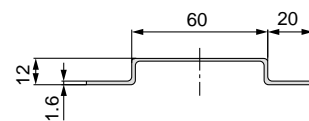

#### L-bracket

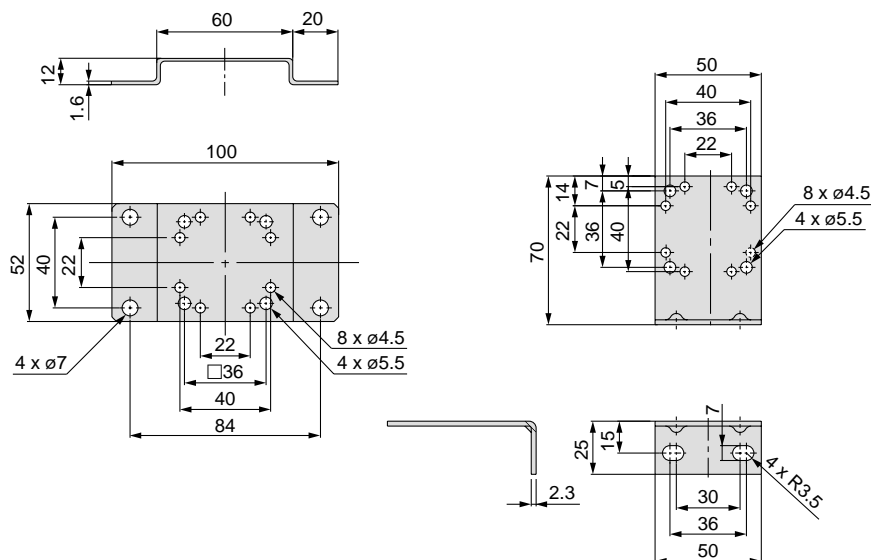

# Series ITV1000/2000/3000

## Working Principles

When the input signal rises, the air supply solenoid valve ① turns ON, and the exhaust solenoid valve ② turns OFF. Therefore, supply pressure passes through the air supply solenoid valve ① and is applied to the pilot chamber ③. The pressure in the pilot chamber ③ increases and operates on the upper surface of the diaphragm ④.

As a result, the air supply valve ⑤ linked to the diaphragm ④ opens, and a portion of the supply pressure becomes output pressure.

This output pressure feeds back to the control circuit ⑧ via the pressure sensor ⑦. Here, a correct operation functions until the output pressure is proportional to the input signal, making it possible to always obtain output pressure proportional to the input signal.

### Working Principle Diagram

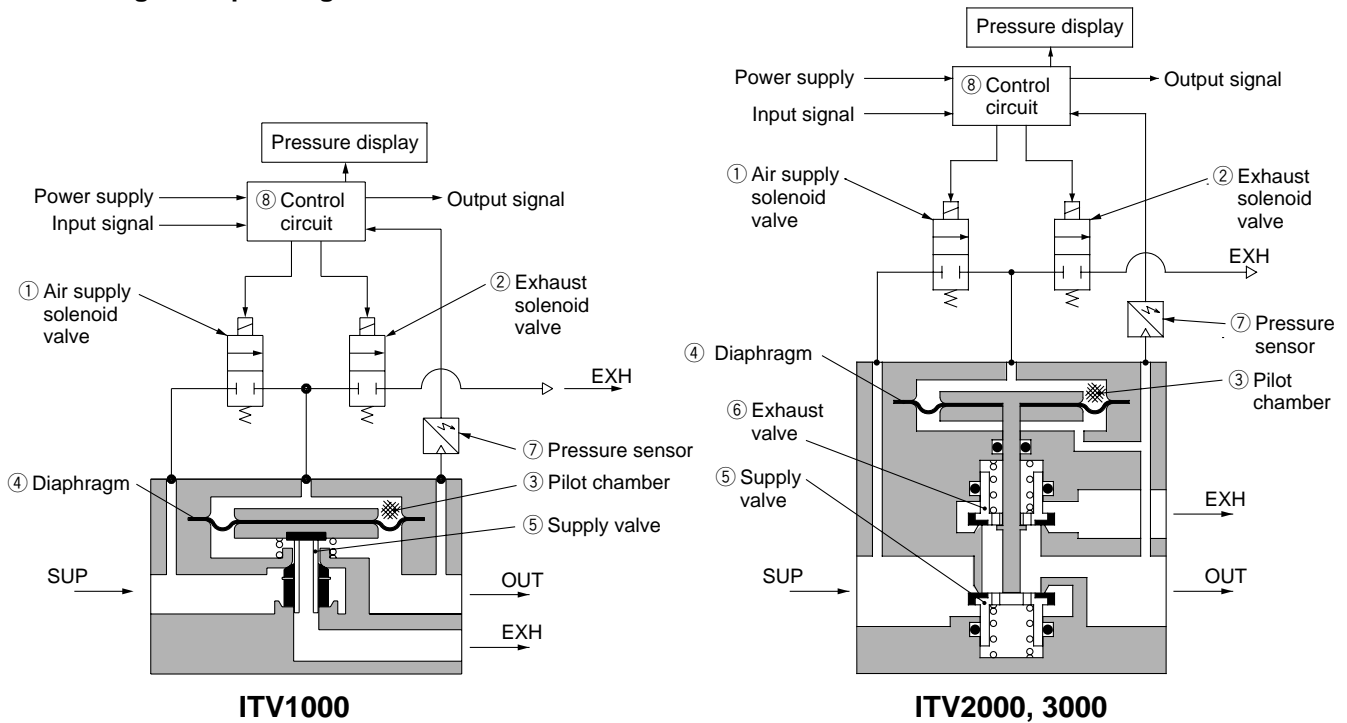

### Block diagram

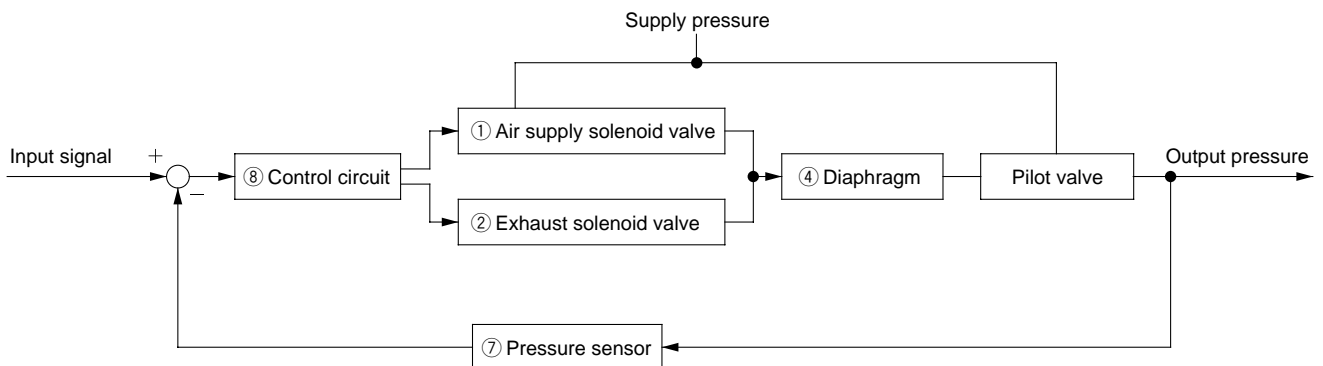

## Series ITV101

### Linearity

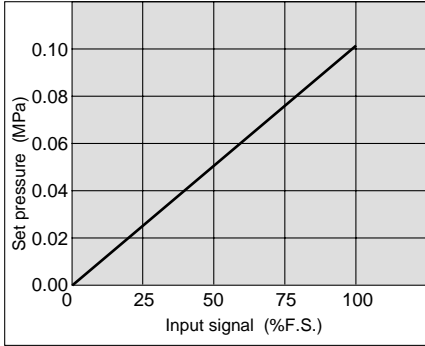

### Hysteresis

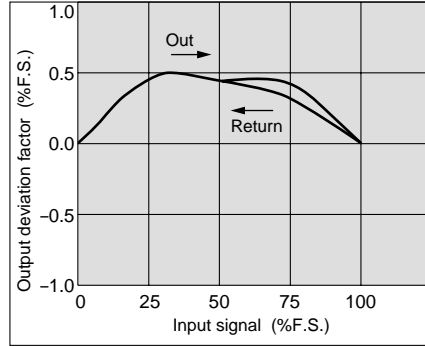

### Repeatability

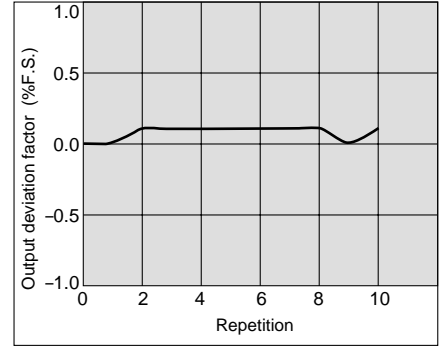

### Pressure characteristics Set pressure: 0.05 MPa

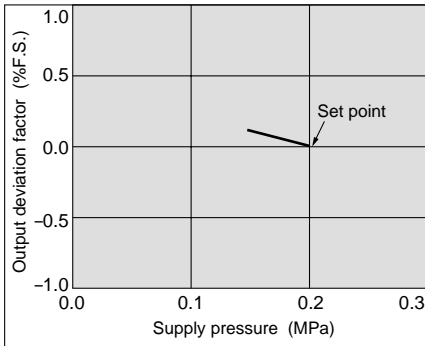

### Flow characteristics Supply pressure: 0.2 MPa

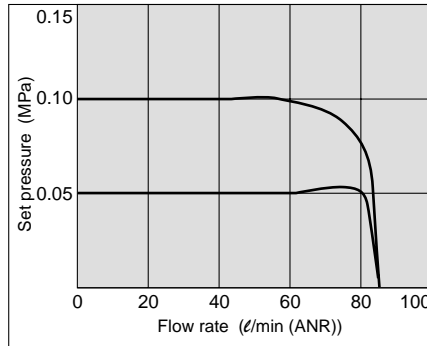

### Relief flow characteristics Supply pressure: 0.2 MPa

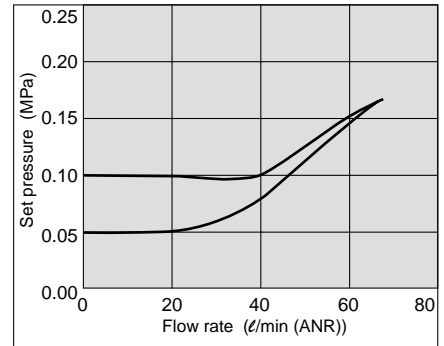

## Series ITV201

### Linearity

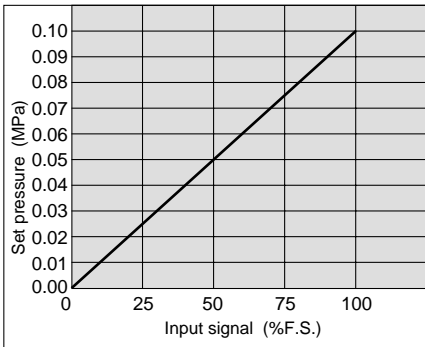

### Hysteresis

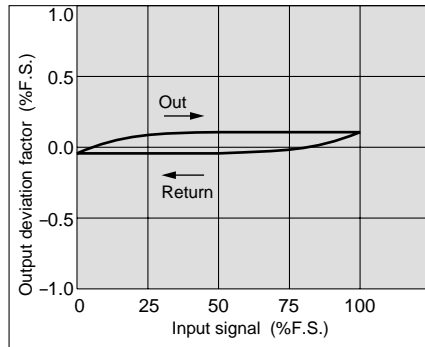

### Repeatability

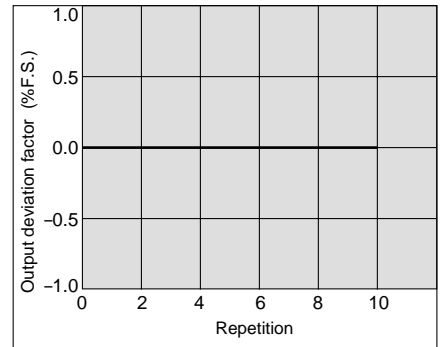

### Pressure characteristics Set pressure: 0.05 MPa

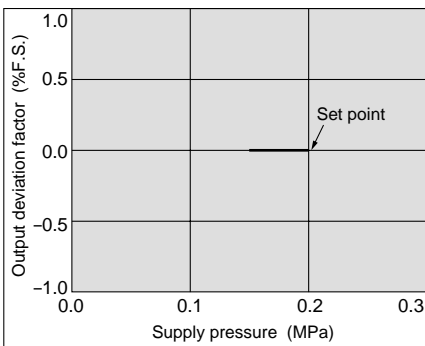

### Flow characteristics Supply pressure: 0.2 MPa

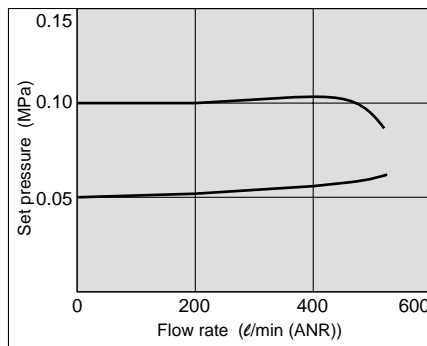

### Relief flow characteristics Supply pressure: 0.2 MPa

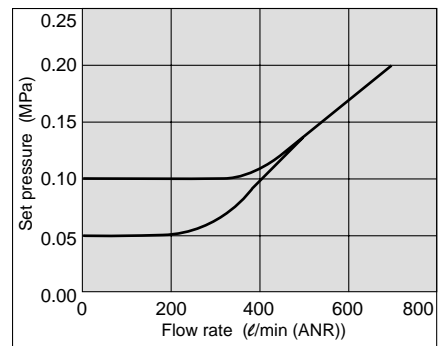

# Series ITV1000/2000/3000

## Series ITV301

### Linearity

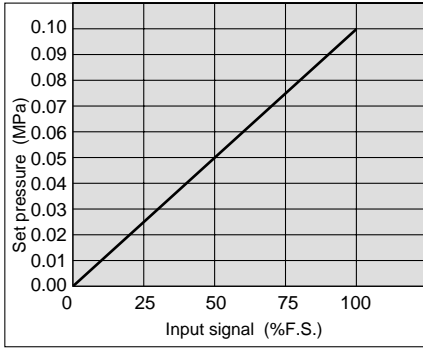

### Hysteresis

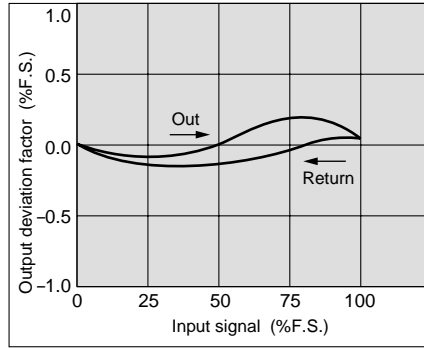

### Repeatability

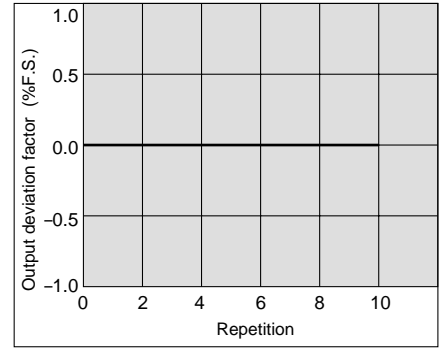

### Pressure characteristics Set pressure: 0.05 MPa

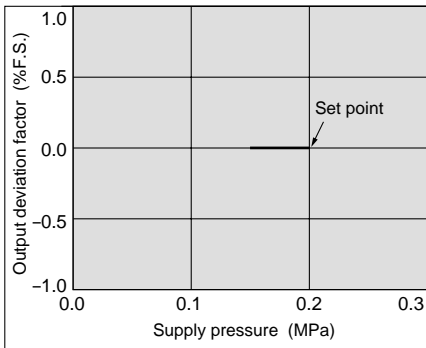

### Flow characteristics Supply pressure: 0.2 MPa

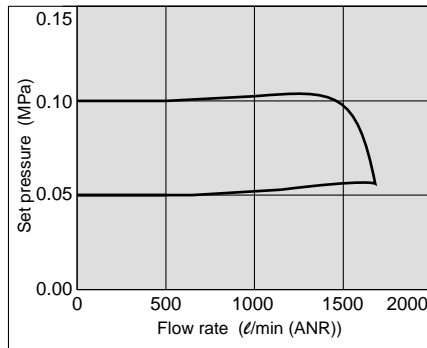

### Relief flow characteristics Supply pressure: 0.2 MPa

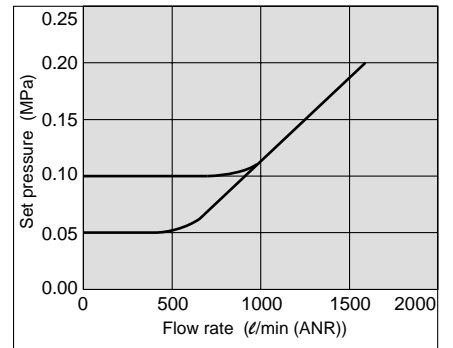

## Series ITV103

### Linearity

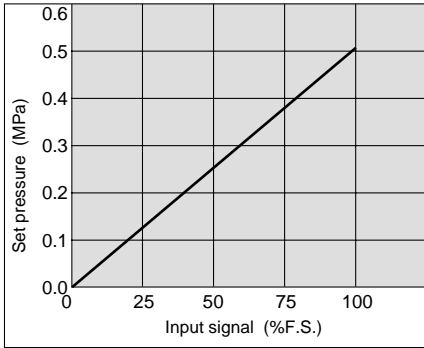

### Hysteresis

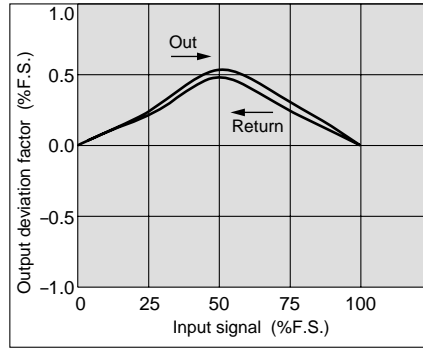

### Repeatability

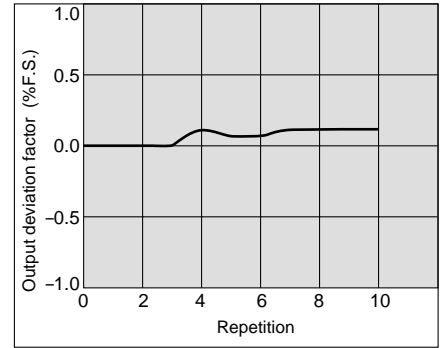

### Pressure characteristics Set pressure: 0.2 MPa

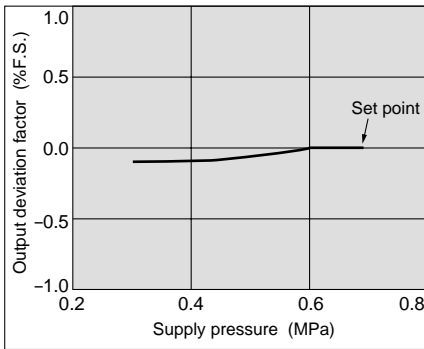

### Flow characteristics Supply pressure: 0.7 MPa

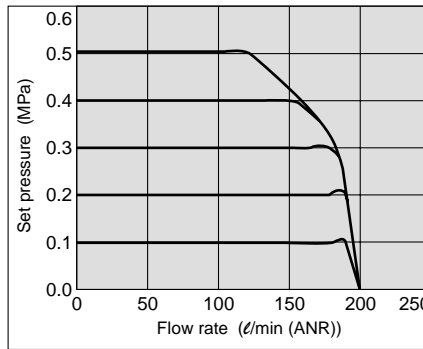

### Relief flow characteristics Supply pressure: 0.7 MPa

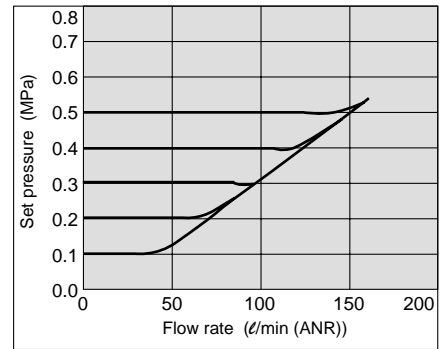

## Series ITV203

### Linearity

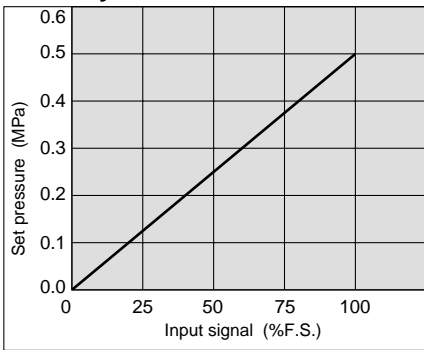

### Hysteresis

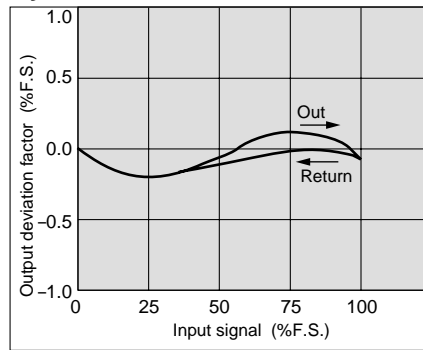

### Repeatability

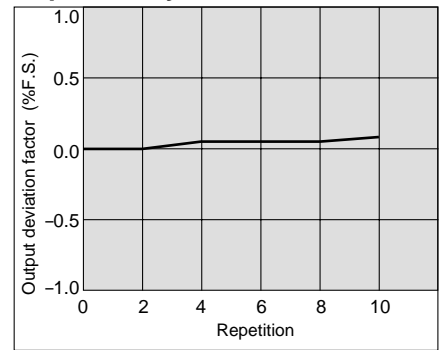

### Pressure characteristics Set pressure: 0.2 MPa

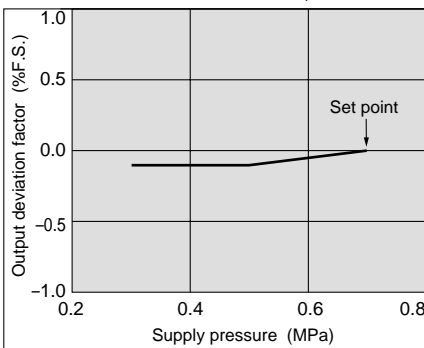

### Flow characteristics Supply pressure: 0.7 MPa

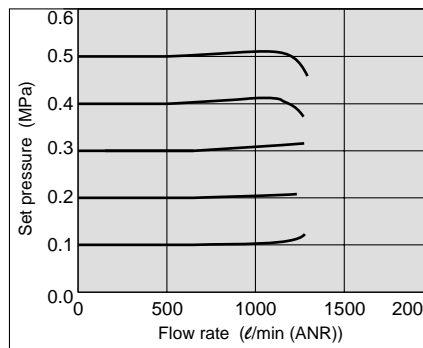

### Relief flow characteristics Supply pressure: 0.7 MPa

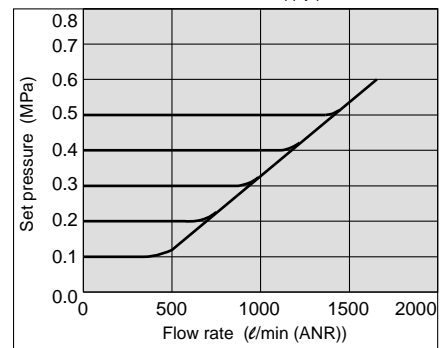

# Series ITV1000/2000/3000

## Series ITV303

### Linearity

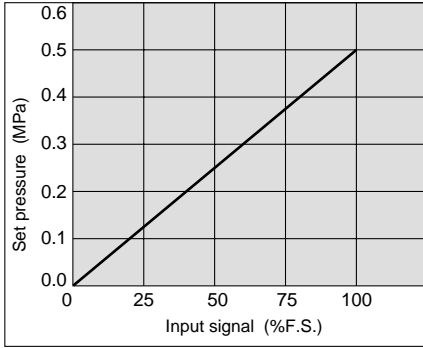

### Hysteresis

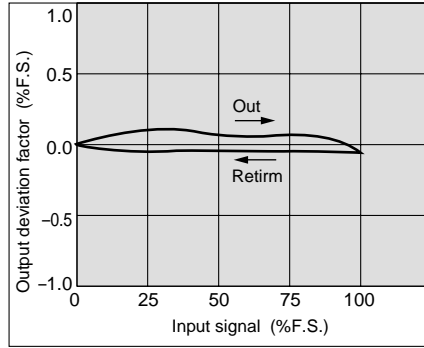

### Repeatability

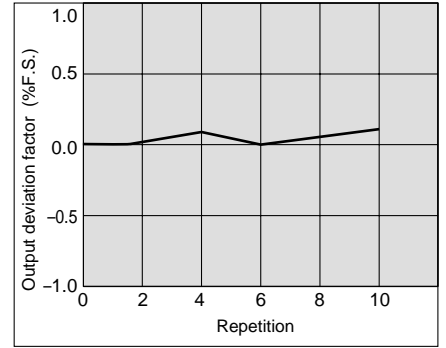

### Pressure characteristics Set pressure: 0.2 MPa

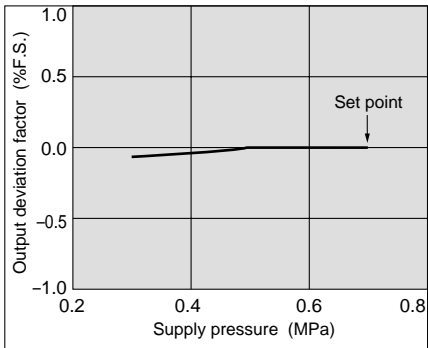

### Flow characteristics Supply pressure: 0.7 MPa

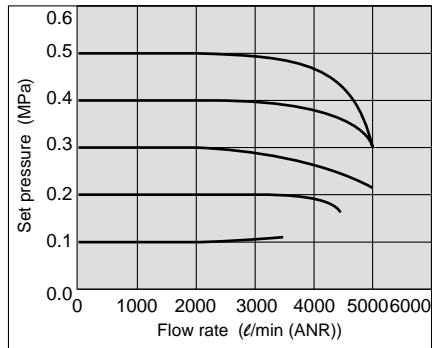

### Relief flow characteristics Supply pressure: 0.7 MPa

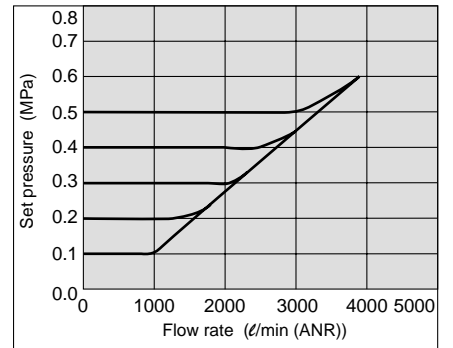



## Series ITV105

### Linearity

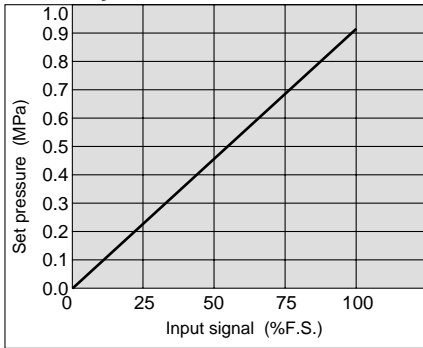

### Hysteresis

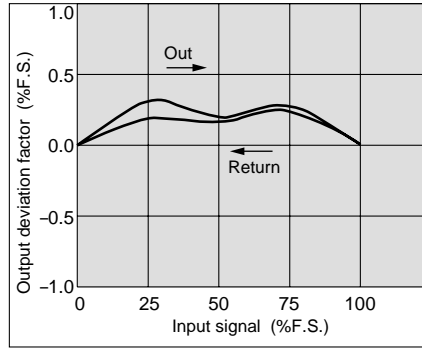

### Repeatability

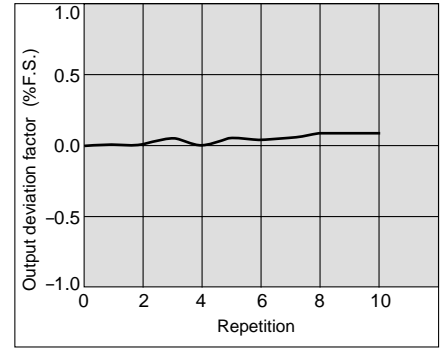

### Pressure characteristics Set pressure: 0.4 MPa

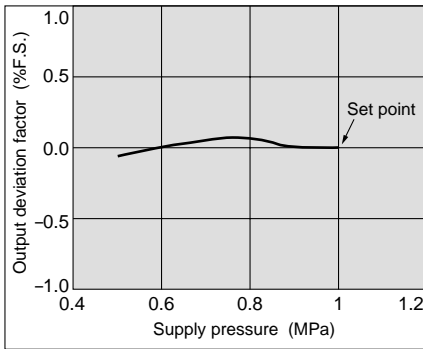

### Flow characteristics Supply pressure: 1.0 MPa

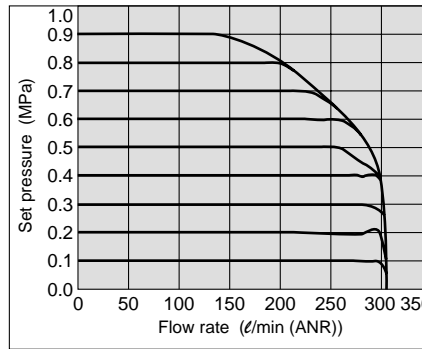

### Relief flow characteristics Supply pressure: 1.0 MPa

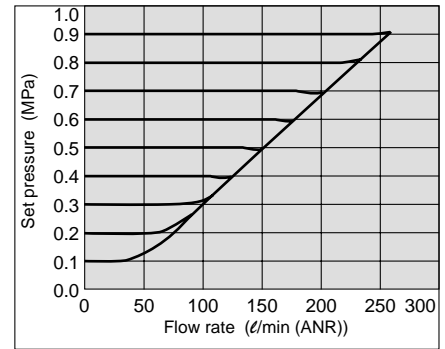

## Series ITV205

### Linearity

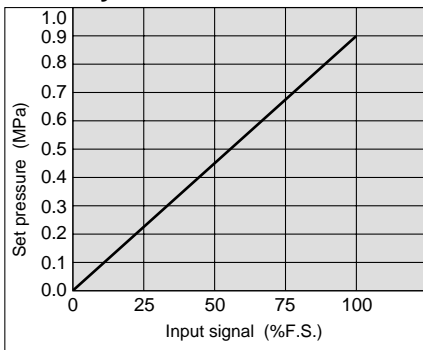

### Hysteresis

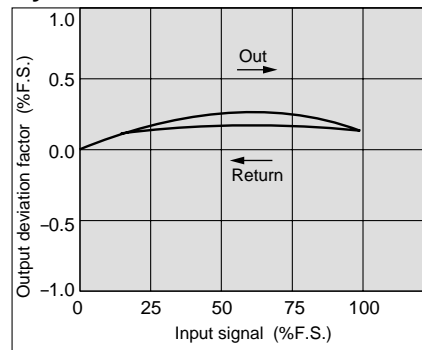

### Repeatability

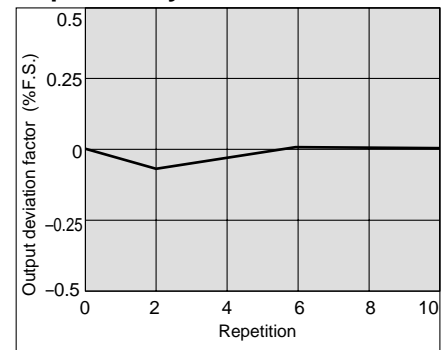

### Pressure characteristics Set pressure: 0.4 MPa

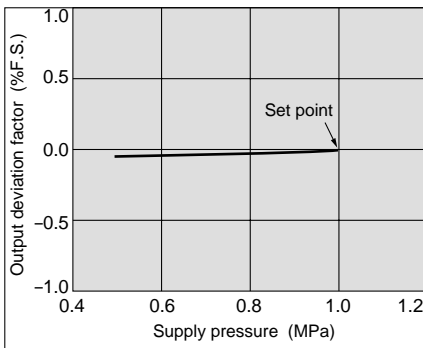

### Flow characteristics Supply pressure: 1.0 MPa

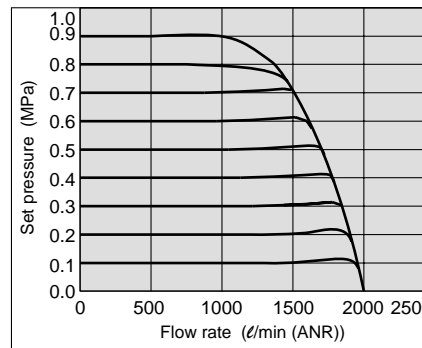

### Relief flow characteristics Supply pressure: 1.0 MPa

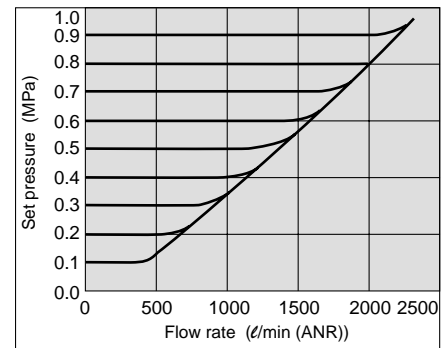

# Series ITV1000/2000/3000

## Series ITV305

### Linearity

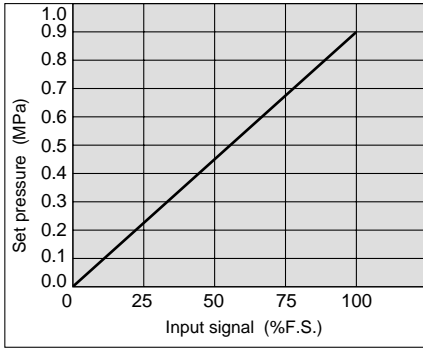

### Hysteresis

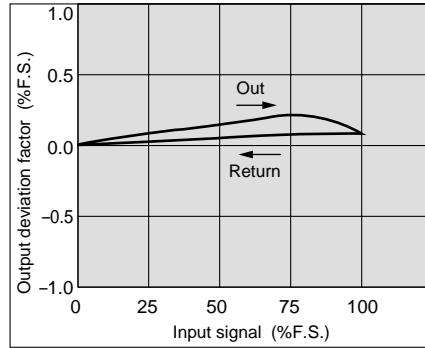

### Repeatability

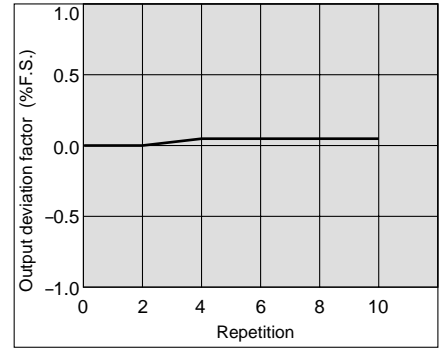

### Pressure characteristics Set pressure: 0.4 MPa

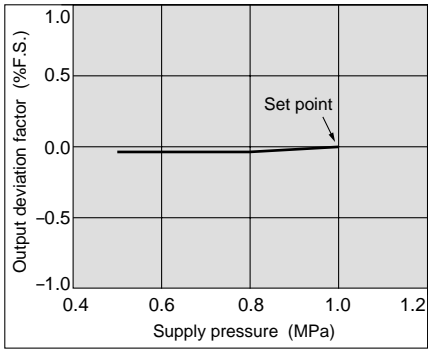

### Flow characteristics Supply pressure: 1.0 MPa

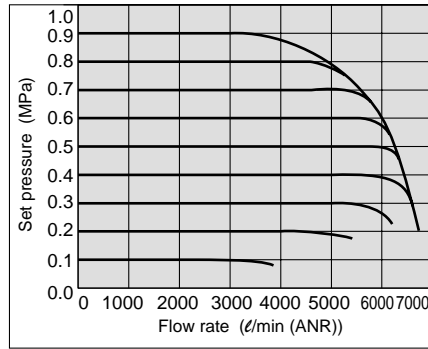

### Relief flow characteristics Supply pressure: 1.0 MPa

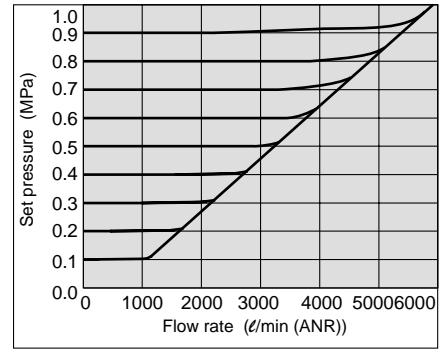

# Electro-Pneumatic Regulator *Series ITV1000/2000/3000*

## Dimensions

ITV10□□

Flat bracket

Note) Do not attempt to rotate, as the cable connector does not turn.

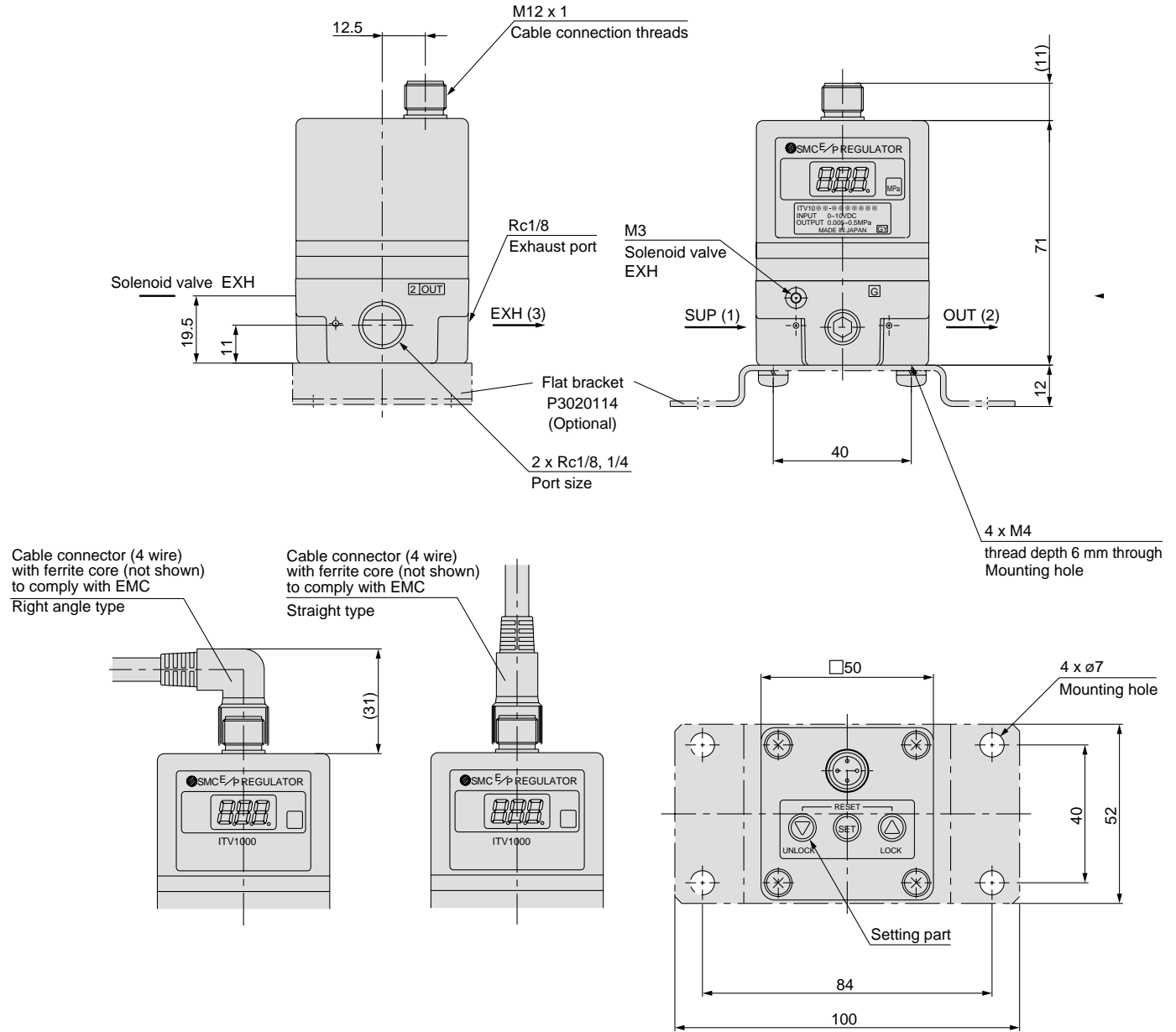

L-bracket

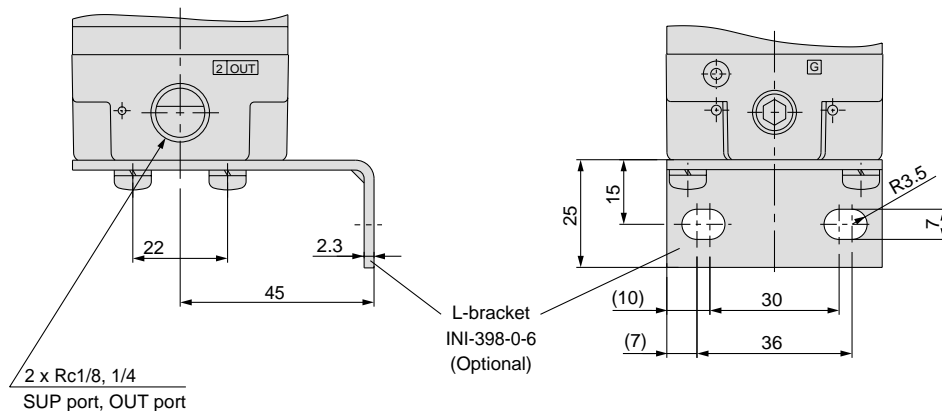

# Series *ITV1000/2000/3000*

## Dimensions

ITV20□□

Flat bracket

Note) Do not attempt to rotate, as the cable connector does not turn.

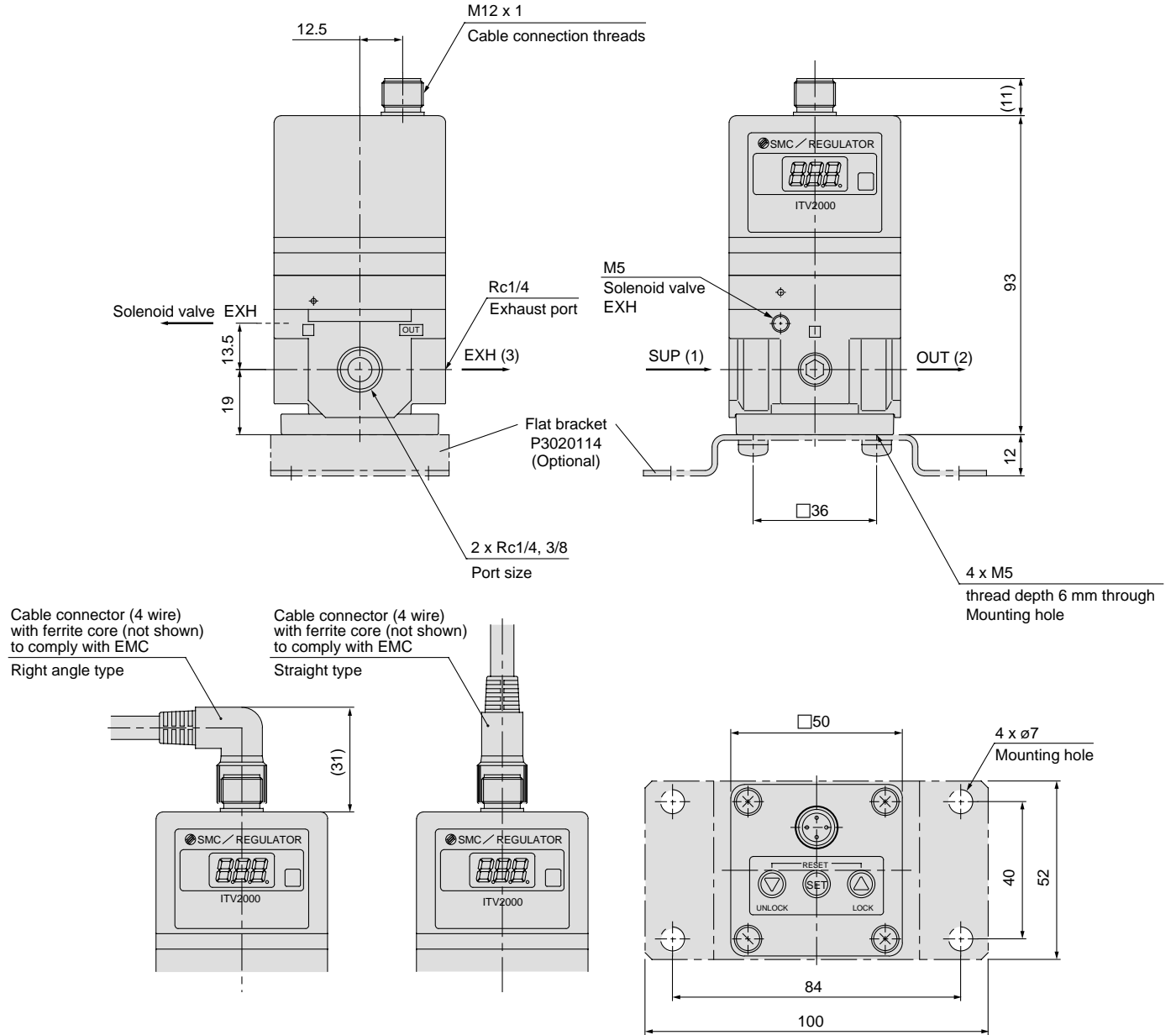

L-bracket

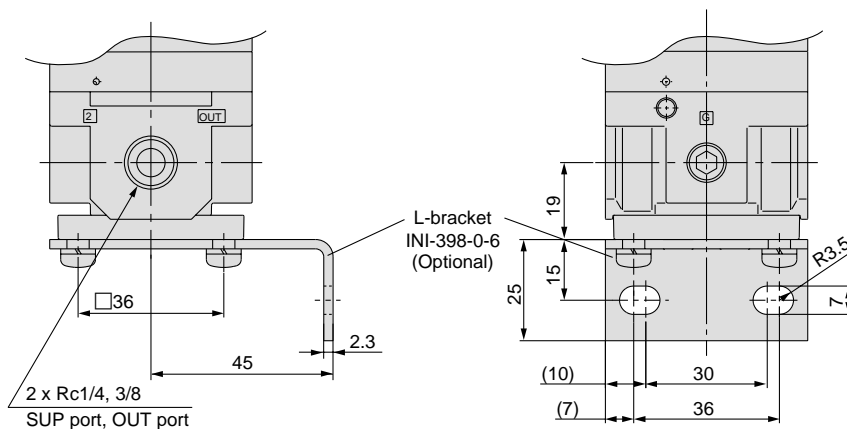

## Dimensions

### ITV30□□

#### Flat bracket

Note) Do not attempt to rotate, as the cable connector does not turn.

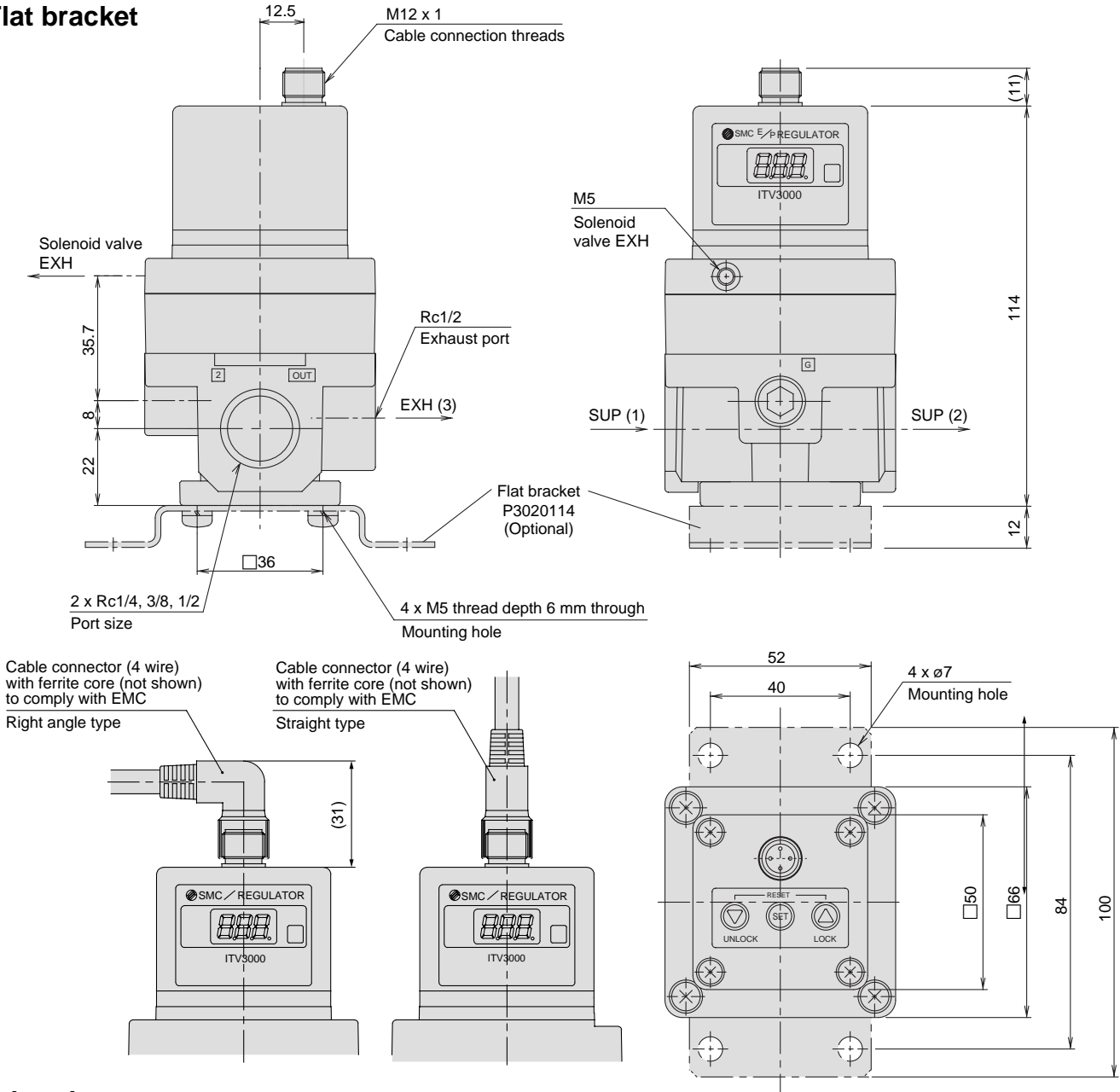

#### L-bracket

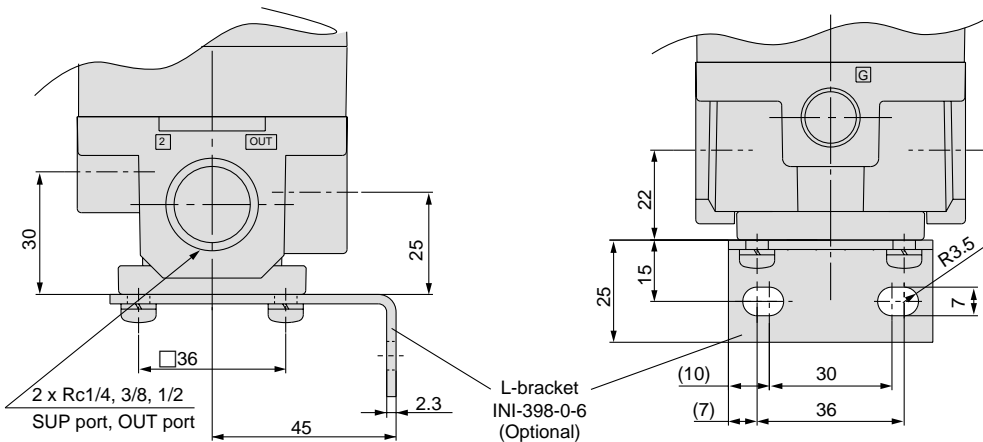

# Series ITV1000/2000/3000 Made to Order Specifications



Contact SMC regarding detailed dimensions, specifications and delivery times.

## 1 Ozone Resistant Specifications

Fluoro rubber is used for the rubber parts of seals.

80 —  Standard model number

● Ozone resistant specifications

## 5 Digital Input Type

Parallel input type with digital 10 bit.

ITV10   0 — 4         — X157

ITV20   0 — 4         — X157

● Digital input type

Note 1)  in part number is the same model no. for the standard products.

## 2 16 Points Preset Input Type

Able to control 16 point pressure by 4 bit switching input

ITV10   0 — 4         — X156

ITV20   0 — 4         — X156

ITV30   0 — 4         — X38

● 16 points preset type

Note 1)  in part number is the same model no. for the standard products.

Note 2) Monitor output is switch output type only.

## 6 DeviceNet Compliant

It is conforming to DeviceNet.

ITV10   0 — 4  0       — X155

ITV20   0 — 4  0       — X155

ITV30   0 — 4  0       — X37

● DeviceNet compliant

Note 1)  in part number is the same model no. for the standard products.

Note 2) The pressure is not indicated.

## 3 N.C. Type

ITV10   —         — X158

ITV20   —         — X158

Note 1)  in part number is the same model no. for the standard products.

## 7 Monitor Analogue output 4-20mA (source type)

ITV20   —  4        — X256

Note 1)  in part number is the same model no. for the standard products.

## 4 High pressure (1MPa) Type

ITV305   —         — X15

## 8 For Pressurized Enclosure

ITV30   —         — X7

## 9 High Speed Manifold Type

ITV20   —         — X208

Note 1)  in part number is the same model no. for the standard products.

# Series ITV1000/2000/3000 Made to Order Specifications



Contact SMC regarding detailed dimensions, specifications and delivery times.

## 6 Manifold Specifications (Except Series ITV3000)

2 through 8 station manifold.

### How to Order Manifolds

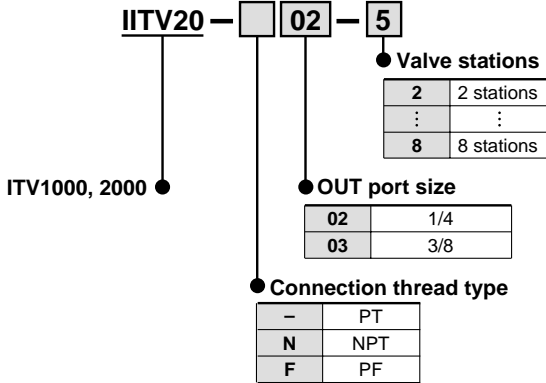

IITV20-02-3 ..... 1 set (3 station manifold base part no.)  
 \*ITV2030-311S-X153 ..... 1 set (Electro-pneumatic regulator part no.) Note 2)  
 \*P398020-13 ..... 1 set (Blanking plate assembly part no.) Note 2)  
 \*ITV2050-212S-X153 ..... 1 set (Electro-pneumatic regulator part no.) Note 2)  
 ↳ The \* is the symbol for mounting. Add the \* symbol at the beginning of part numbers for electro-pneumatic regulators, etc. to be mounted on the base.

Note) Refer to the table below for possible mixed combination.

Model	ITV101□	ITV103□	ITV105□	ITV201□	ITV203□	ITV205□
ITV101□	●	—	—	●	—	—
ITV103□	—	●	●	—	●	●
ITV105□	—	●	●	—	●	●
ITV201□	●	—	—	●	—	—
ITV203□	—	●	●	—	●	●
ITV205□	—	●	●	—	●	●

### How to Order Manifold Assemblies

#### Example

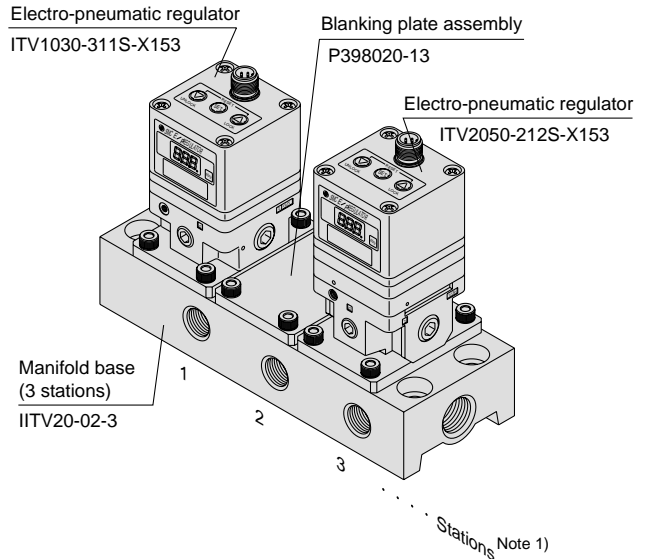

Note 1) Electro-pneumatic regulators are counted starting from station 1 on the left side with the OUT ports in front.

Note 2) The port size for mounted electro-pneumatic regulators is Rc1/8 (ITV1000), Rc1/4 (ITV2000) only.

Note 3) When there is a large number of stations, use piping with the largest possible inside diameter for the supply side, such as steel piping.

Note 4) The use of the straight type cable connector is recommended. To mount right angle type, be certain to check that no possible interference occurs.

Note 5) When mounting a blanking plate and the regulator with different pressure set, please inform SMC of the order of a manifold station beside a purchase order.

## 7 High-Speed Response Time Specifications

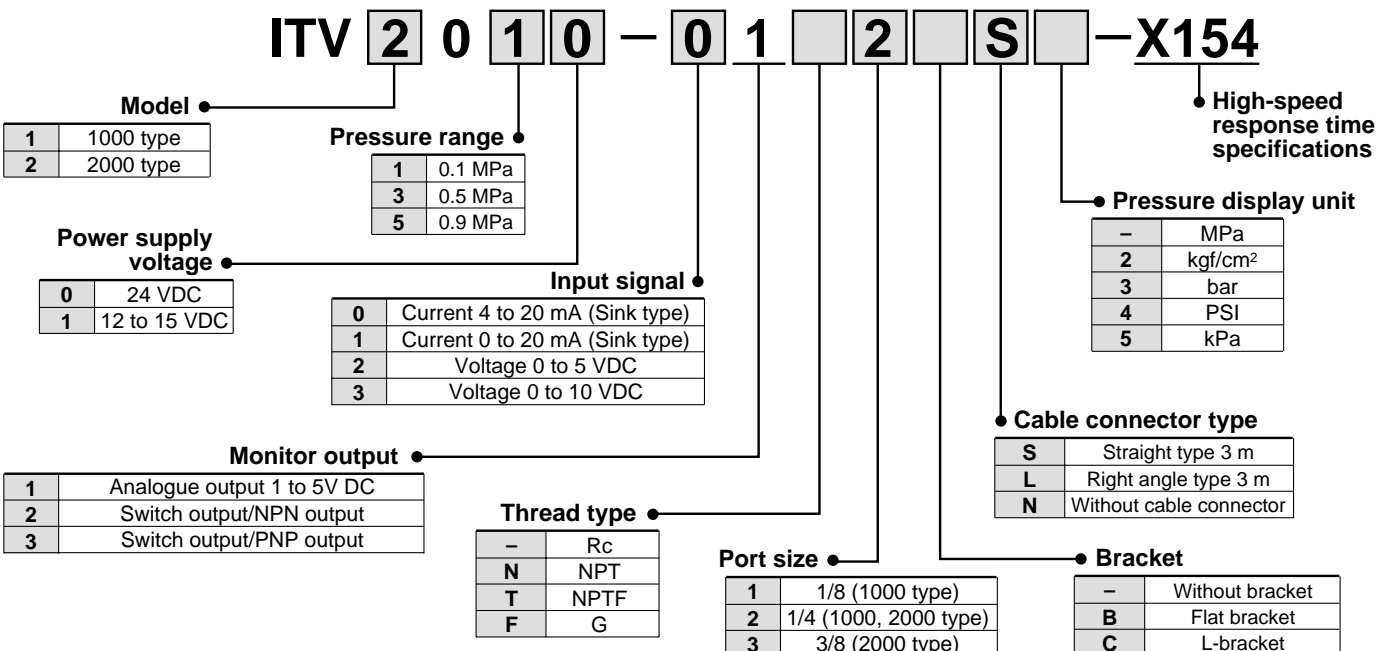

Pressure response with no load is approx. 0.1 sec.





# Series ITV1000/2000/3000 Safety Instructions

These safety instructions are intended to prevent a hazardous situation and/or equipment damage. These instructions indicate the level of potential hazard by labels of "Caution", "Warning" or "Danger". To ensure safety, be sure to observe ISO 4414 <sup>Note 1)</sup>, JIS B 8370 <sup>Note 2)</sup> and other safety practices.

-  **Caution** : Operator error could result in injury or equipment damage.
-  **Warning** : Operator error could result in serious injury or loss of life.
-  **Danger** : In extreme conditions, there is a possible result of serious injury or loss of life.

Note 1) ISO 4414: Pneumatic fluid power --General rules relating to systems

Note 2) JIS B 8370: Pneumatic system axiom.

## Warning

### **1. The compatibility of pneumatic equipment is the responsibility of the person who designs the pneumatic system or decides its specifications.**

Since the products specified here are used in various operating conditions, their compatibility with the specific pneumatic system must be based on specifications or after analysis and/or tests to meet your specific requirements. The expected performance and safety assurance will be the responsibility of the person who has determined the compatibility of the system. This person should continuously review the suitability of all items specified, referring to the latest catalogue information with a view to giving due consideration to any possibility of equipment failure when configuring a system.

### **2. Only trained personnel should operate pneumatically operated machinery and equipment.**

Compressed air can be dangerous if handled incorrectly. Assembly, handling or maintenance of pneumatic systems should be performed by trained and experienced operators.

### **3. Do not service machinery/equipment or attempt to remove components until safety is confirmed.**

1. Inspection and maintenance of machinery/equipment should only be performed once measures to prevent falling or runaway of the driven object have been confirmed.
2. When equipment is to be removed, confirm the safety process as mentioned above. Cut the supply pressure for this equipment and exhaust all residual compressed air in the system.
3. Before machinery/equipment is restarted, take measures to prevent shooting-out of cylinder piston rod, etc.

### **4. Contact SMC if the product is to be used in any of the following conditions:**

1. Conditions and environments beyond the given specifications, or if product is used outdoors.
2. Installation on equipment in conjunction with atomic energy, railway, air navigation, vehicles, medical equipment, food and beverages, recreation equipment, emergency stop circuits, clutch and brake circuit in press applications, or safety equipment.
3. An application which has the possibility of having negative effects on people, property, or animals, requiring special safety analysis.





# Series ITV1000/2000/3000

## Electro-Pneumatic Regulator Precautions

Be sure to read before handling.

### Piping

#### Warning

##### 1. Screw piping together with the recommended proper torque while holding the side that has female threads.

Looseness or faulty sealing will occur if tightening torque is insufficient, while thread damage will result if the torque is excessive. Furthermore, if the side with the female threads is not held while tightening, excessive force will be applied directly to piping brackets, etc. causing damage or other problems.

Recommended proper torque: N · m (kgf · cm)

Connection thread	1/8	1/4	3/8	1/2
Torque	7 to 9 (70 to 90)	12 to 14 (120 to 140)	22 to 24 (220 to 240)	28 to 30 (280 to 300)

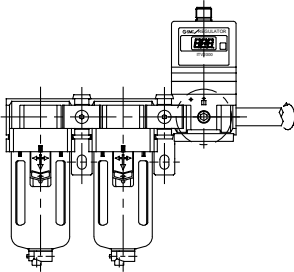

##### 2. Do not allow twisting or bending moment to be applied other than the weight of the equipment itself.

Provide separate support for external piping, as damage may otherwise occur.

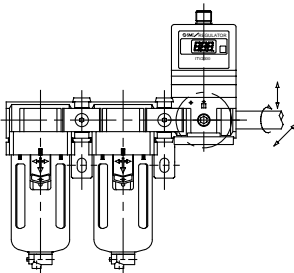

##### 3. Since excessive moment loads and the propagation of vibrations, etc. can easily result from inflexible piping made of materials such as steel, avoid these problems by using flexible tubing for intermediate connections.

#### Caution

##### 1. Preparation before piping

Before piping is connected, it should be thoroughly blown out with air (flushing) or washed to remove chips, cutting oil and other debris from inside the pipe.

### Piping

##### 2. Wrapping of pipe tape

When screwing together pipes and fittings, etc., be certain that chips from the pipe threads and sealing material do not get inside the piping.

Also, when pipe tape is used, leave 1.5 to 2 thread ridges exposed at the end of the threads.

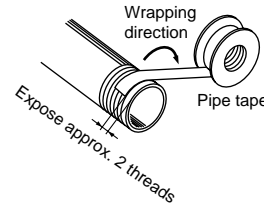

### Operating Environment

#### Warning

1. Do not operate in locations having an atmosphere of corrosive gases, chemicals, sea water, or where there will be contact with the same.
2. Do not operate in locations where vibration or impact occurs.
3. In locations which receive direct sunlight, provide a protective cover, etc.
4. In locations near heat sources, block off any radiated heat.
5. In locations where there is contact with spatter from water, oil or solder, etc., implement suitable protective measures.

#### Caution

In locations where the body is exposed to water, steam, dust, etc., there is a possibility that moisture or dust could enter the body through the EXH (solenoid) ports, thereby causing problems. To overcome this, simply install tubing to each port, using the fittings, and extend the tubing so that the other end is at a location where no water splash, etc. occurs. Make sure not to bend, or block the I.D. of the tubing as this will have a detrimental affect on the pressure control.

### Air Supply

#### Warning

1. These products are designed for use with compressed air. Contact SMC if any other fluid will be used.
2. Do not use compressed air which includes chemicals, synthetic oils containing organic solvents, salt, or corrosive gases, etc., as this can cause damage or malfunction.



## Series ITV1000/2000/3000

# Specific Product Precautions 1

Be sure to read before handling.

Refer to pages 15 and 16 for safety instructions and precautions.

### Operating Environment

#### Warning

1. Employ suitable protective measures in locations where there is contact with water droplets, oil or welding spatter, etc.
2. Consult SMC when used in power plants, or if instrumentation related.

### Air Supply

#### Caution

1. Install an air filter near this product on the supply side. Select a filtration degree of 5  $\mu\text{m}$  or less.
2. Compressed air containing large amounts of drainage can cause malfunction of this product and other pneumatic equipment. As a countermeasure, install an aftercooler, air dryer or Drain Catch, etc.
3. If large amounts of carbon dust are generated by the compressor, it can accumulate inside this product and cause malfunction.

For details on the above compressed air quality, refer to SMC's "Best Pneumatics catalogue vol. 4".

### Handling

#### Caution

1. Do not use a lubricator on the supply side of this product, as this can cause malfunction. When lubrication of terminal equipment is necessary, connect a lubricator on the output side of this equipment.
2. If electric power is shut off while pressure is being applied, pressure will be retained on the output side.  
However, this output pressure is held only temporarily and is not guaranteed. If exhausting of this pressure is desired, shut off the power after reducing the set pressure, and discharge the air using a residual pressure exhaust valve, etc.
3. If power to this product is cut off due to a power failure, etc. when it is in a controlled state, output pressure will be retained temporarily. Handle carefully when operating with output pressure released to the atmosphere, as air will continue to flow out.

### Handling

#### Caution

4. If supply pressure to this product is interrupted while the power is still on, the internal solenoid valve will continue to operate and a humming noise may be generated. Since the life of the product may be shortened, shut off the power supply also when supply pressure is shut off.
5. In this product, the output side pressure cannot be completely relieved within the range of 0.005 MPa or less. If it is desired to reduce the pressure completely to 0 MPa, install a 3 way valve or other device on the output side to exhaust the pressure.
6. This product is adjusted for each specification at the time of shipment from the factory. Avoid careless disassembly or removal of parts, as this can lead to malfunction.
7. The optional cable connector is a 4 wire type. When the monitor output (analog output or switch output) is not being used, keep it from touching the other wires as this can cause malfunction.
8. Please note that the right angle cable does not rotate and is limited to only one entry direction.
9. Take the following steps to avoid malfunction due to noise.
  - 1) Remove power supply noise during operation by installing a line filter, etc. in the AC power line.
  - 2) For avoiding the influence of noise install this product and its wiring as far as possible from strong electric fields such as those of motors and power lines, etc.
  - 3) Be sure to implement protective measures against load surge for induction loads (solenoid valves, relays, etc.).
  - 4) Install or remove the connector after shutting off the power supply to avoid the influence of chattering of the power supply.
10. Due to the large volume of the output side, a loud exhaust noise will be produced when being used for the purpose of a relief function. Therefore, install a silencer (SMC Series AN200 or AN400) on the exhaust port (EXH port). The port sizes are Rc1/8, Rc1/4 and Rc1/2.
11. Specifications on page 1 is in case of static environment. Pressure may fluctuate when air is consumed at the output side.
12. For details on the handling of this product, refer to the instruction manual which is included with the product.



# Series ITV1000/2000/3000 Specific Product Precautions 2

Be sure to read before handling.  
Refer to pages 15 and 16 for safety instructions and precautions.

## Wiring

### ⚠ Caution

Connect the cable to the connector on the body with the wiring arranged as shown below. Proceed carefully, as incorrect wiring can cause damage. Further, use DC power with sufficient capacity and a low ripple.



#### Current signal type Voltage signal type

1	Brown	Power supply
2	White	Input signal
3	Blue	GND (COMMON)
4	Black	Monitor output

#### Preset input type

1	Brown	Power supply
2	White	Input signal
3	Blue	GND (COMMON)
4	Black	Monitor output

Note) A right angle type cable is also available.  
The entry direction for the right angle type connector is to the left (SUP port side).  
Never turn the connector as it is not designed to turn.

### Wiring diagram

#### Current signal type

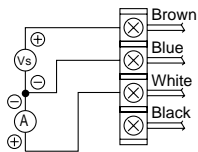

Vs: Power supply 24 VDC  
12 to 15 VDC  
A : Input signal 4 to 20 mADC  
0 to 20 mADC

#### Voltage signal type

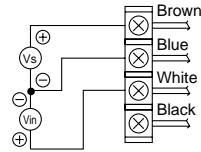

Vs : Power supply 24 VDC  
12 to 15 VDC  
Vin: Input signal 0 to 5 VDC  
0 to 10 VDC

#### Preset input type

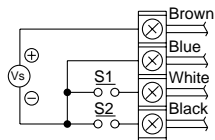

Vs: Power supply 24 VDC  
12 to 15 VDC

One of the preset pressures P1 through P4 is selected by the ON/OFF combination of S1 and S2.

S1	OFF	ON	OFF	ON
S2	OFF	OFF	ON	ON
Preset pressure	P1	P2	P3	P4

\* For safety reasons, it is recommended that one of the preset pressures be set to 0 MPa.

### Monitor output wiring diagram

#### Analogue output, voltage type

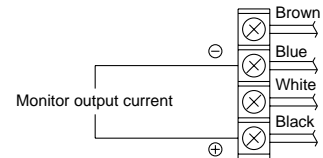

#### Switch output, NPN type

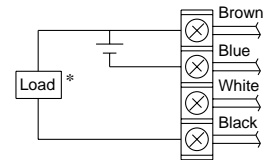

#### Switch output, PNP type

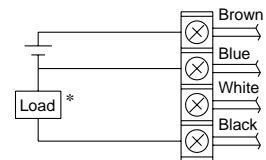

#### Analogue output, current type (sink type)

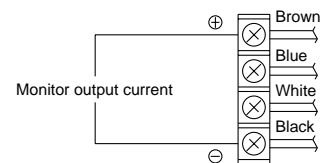

\* When 30 mA DC or more is applied, detecting device for overcurrent starts activating and then emits an error signal.  
(Error number "5")

## Set Pressure Range

The regulating pressure range, by unit of standard measured pressure, is shown in the table below.

#### Regulating pressure range, by unit of standard measured pressure

Unit	Regulating pressure range		
	ITV□01□	ITV□03□	ITV□05□
MPa	0.005 to 0.1	0.005 to 0.5	0.005 to 0.9
kgf/cm <sup>2</sup>	0.05 to 1	0.05 to 5	0.05 to 9
bar	0.05 to 1	0.05 to 5	0.05 to 9
PSI	0.7 to 15	0.7 to 70	0.7 to 130
kPa	5 to 100	5 to 500	5 to 900



## EUROPEAN SUBSIDIARIES:



### Austria

SMC Pneumatik GmbH (Austria).  
Girakstrasse 8, A-2100 Korneuburg  
Phone: +43 2262-62280, Fax: +43 2262-62285  
E-mail: office@smc.at  
http://www.smc.at



### France

SMC Pneumatique, S.A.  
1, Boulevard de Strasbourg, Parc Gustave Eiffel  
Bussy Saint Georges  
F-77607 Marne La Vallee Cedex 3  
Phone: 01-6476 1000, Fax: 01-6476 1010  
http://www.smc-france.fr



### Lithuania

UAB Ottensten Lietuva  
Savanoriu pr. 180, LT-2600 Vilnius, Lithuania  
Phone/Fax: 370-2651602



### Slovakia

SMC Priemyselna Automatizacia, s.r.o.  
Namestie Martina Benku 10  
SK-81107 Bratislava  
Phone: +421 2 444 56725, Fax: +421 2 444 56028  
E-mail: office@smc.sk  
http://www.smc.sk



### Belgium

SMC Pneumatics N.V./S.A.  
Nijverheidsstraat 20, B-2160 Wommelgem  
Phone: 03-355-1464, Fax: 03-355-1466  
E-mail: post@smcpneumatics.be



### Germany

SMC Pneumatik GmbH  
Boschring 13-15, D-63329 Egelsbach  
Phone: 06103-4020, Fax: 06103-402139  
E-mail: info@smc-pneumatik.de  
http://www.smc-pneumatik.de



### Netherlands

SMC Pneumatics BV  
De Ruyterkade 120, NL-1011 AB Amsterdam  
Phone: 020-5318888, Fax: 020-5318880  
E-mail: info@smcpneumatics.nl



### Slovenia

SMC industrijska Avtomatika d.o.o.  
Grajski trg 15, SLO-8360 Zuzemberk  
Phone: +386 738 85240 Fax: +386 738 85249  
E-mail: office@smc-ind-avtom.si  
http://www.smc-ind-avtom.si



### Bulgaria

SMC Industrial Automation Bulgaria o.o.d.  
Vitinia str., bl. 89, entr. V app. 41, BG-1517 Sofia  
Phone: +359 2 9744492, Fax: +359 2 9744519  
E-mail: sales@smc.at  
http://www.smc.bg



### Greece

S. Parianopoulos S.A.  
7, Konstantinoupolleos Street,  
GR-11855 Athens  
Phone: 01-3426076, Fax: 01-3455578



### Norway

SMC Pneumatics Norway A/S  
Vollsveien 13 C, Granfos Næringspark  
N-1366 Lysaker  
Tel: (47) 67 12 90 20, Fax: (47) 67 12 90 21  
http://www.smc-norge.no



### Spain

SMC España, S.A.  
Zuazobidea 14  
01015 Vitoria  
Phone: 945-184 100, Fax: 945-184 124  
E-mail: post@smc.smces.es



### Czech Republic

SMC Industrial Automation CZ s.r.o.  
Hudcova 78a, CZ-61200 Brno  
Phone: +420 5 414 24611, Fax: +420 5 412 18034  
E-mail: office@smc.cz  
http://www.smc.cz



### Hungary

SMC Hungary Ipari Automatizálási Kft.  
Budafoki ut 107-113, H-1117 Budapest  
Phone: +36 1 371 1343, Fax: +36 1 371 1344  
E-mail: office@smc-automation.hu  
http://www.smc-automation.hu



### Poland

SMC Industrial Automation Polska Sp.z.o.o.  
ul. Konstruktorska 11A, PL-02-673 Warszawa,  
Phone: +48 22 548 5085, Fax: +48 22 548 5087  
E-mail: office@smc.pl  
http://www.smc.pl



### Sweden

SMC Pneumatics Sweden AB  
Ekhagsvägen 29-31, S-141 71 Huddinge  
Phone: 08-603 07 00, Fax: 08-603 07 10  
http://www.smc.nu



### Denmark

SMC Pneumatik A/S  
Knudsminde 4B, DK-8300 Odder  
Phone: (45)70252900, Fax: (45)70252901  
E-mail: smc@smc-pneumatik.dk



### Ireland

SMC Pneumatics (Ireland) Ltd.  
2002 Citywest Business Campus,  
Naas Road, Saggart, Co. Dublin  
Phone: 01-403 9000, Fax: 01-464-0500



### Portugal

SMC Sucursal Portugal, S.A.  
Rua de Engº Ferreira Dias 452, 4100-246 Porto  
Phone: 22-610-89-22, Fax: 22-610-89-36  
E-mail: postpt@smc.smces.es



### Switzerland

SMC Pneumatik AG  
Dorfstrasse 7, CH-8484 Weisslingen  
Phone: 052-396-3131, Fax: 052-396-3191  
E-mail: info@smc.ch  
http://www.smc.ch



### Estonia

SMC Pneumatics Estonia OÜ  
Laki 12-101, 106 21 Tallinn  
Phone: 06 593540, Fax: 06 593541  
http://www.smc-pneumatics.ee



### Italy

SMC Italia S.p.A.  
Via Garibaldi 62, I-20061 Carugate, (Milano)  
Phone: 02-92711, Fax: 02-9271365  
E-mail: mailbox@smcitalia.it  
http://www.smcitalia.it



### Romania

SMC Romania srl  
Str. Frunzei 29, Sector 2, Bucharest  
Phone: 01-324-2626, Fax: 01-324-2627  
E-mail: smccadm@canad.ro  
http://www.smcromania.ro



### Turkey

Entek Pnömatik San. ve Tic.Ltd. Sti.  
Perpa Tic. Merkezi Kat: 11 No: 1625,  
TR-80270 Okmeydanı Istanbul  
Phone: 0212-221-1512, Fax: 0212-221-1519  
http://www.entek.com.tr



### Finland

SMC Pneumatics Finland OY  
PL72, Tiistiniityntie 4, SF-02031 ESPOO  
Phone: 09-859 580, Fax: 09-8595 8595  
http://www.smcfitec.sci.fi



### Latvia

SMC Pneumatics Latvia SIA  
Smerla 1-705, Riga LV-1006, Latvia  
Phone: 0777-94-74, Fax: 0777-94-75  
http://www.smclv.lv



### Russia

SMC Pneumatik LLC.  
36/40 Sredny pr. St. Petersburg 199004  
Phone: (812) 118 5445, Fax: (812) 118 5449  
E-mail: smcfa@peterlink.ru  
http://www.smc-pneumatik.ru



### UK

SMC Pneumatics (UK) Ltd  
Vincent Avenue, Crownhill,  
Milton Keynes, MK8 0AN  
Phone: 0800 1382930 Fax: 01908-555064  
E-mail: sales@smcpneumatics.co.uk  
http://www.smc-pneumatics.co.uk



## OTHER SUBSIDIARIES WORLDWIDE:

ARGENTINA, AUSTRALIA, BOLIVIA, BRASIL, CANADA, CHILE, CHINA, HONG KONG, INDIA, MALAYSIA, MEXICO, NEW ZEALAND, PHILIPPINES, SINGAPORE, SOUTH KOREA, TAIWAN, THAILAND, USA, VENEZUELA

<http://www.smceu.com>  
<http://www.smcworld.com>