

Multi-connector Series *DM*

The use of the multi-connector enables panel mount connections with other apparatus and can provide the reliability of one-touch installation and removal of multi-tubes (nylon, polyurethane). As a result, separate transportation of panel and machinery equipment and backup unit exchange are made possible.

One-touch installation and removal

Employs the unique built-in keying mechanism which provides one-touch installation and removal capability even in hard to see locations. In addition, it prevents installation mistakes when re-connecting.

Installation processes are reduced considerably

As compared with the use of many bulkhead unions, this installation is very easy and installation time is reduced considerably.

Reliable tube retaining force

This construction mechanism enables clamping and unclamping every tube in use by one operation and can provide a reliable tube retaining force.

Number of connecting tubes

2 styles - 6 tubes & 12 tubes.

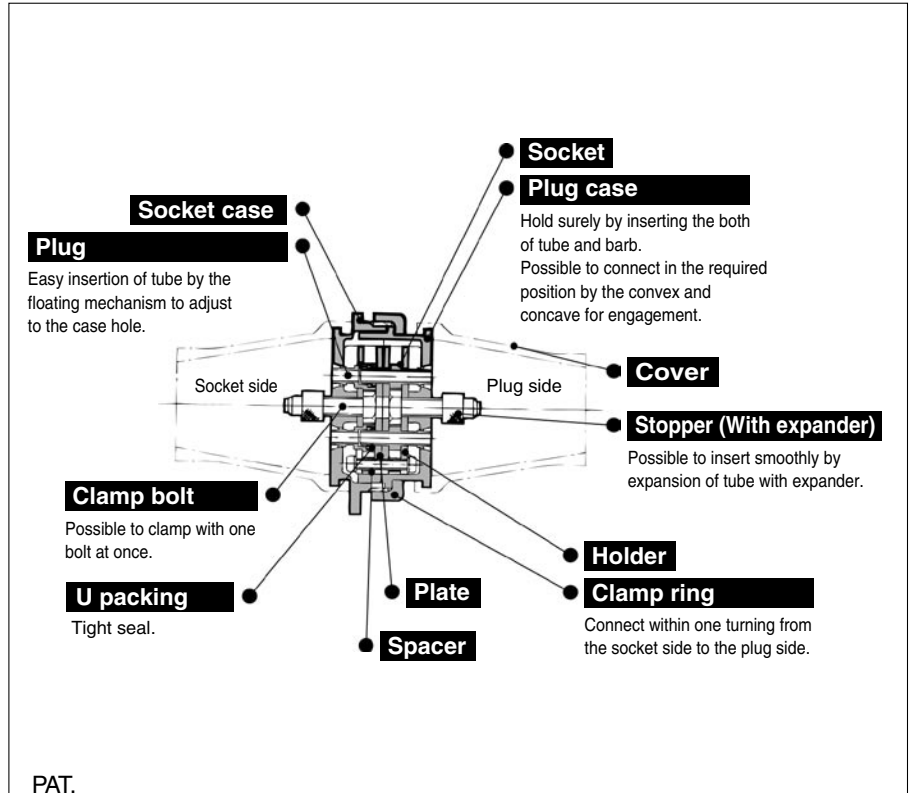
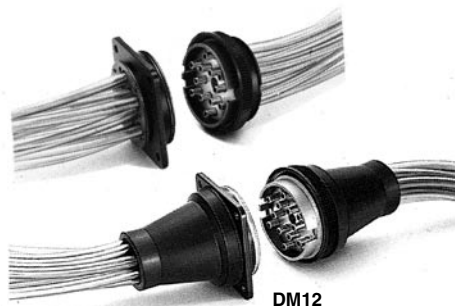

Model

No. of connecting tubes	Part No.			Applicable tubing			Accessories (optional)
	Multiconnector	Plug side only	Socket side only	Nylon	Soft nylon	Polyurethane	
6	DM6-04N	DM6P-04N	DM6S-04N	T0425	—	—	DM-C-6
	DM6-04NU	DM6P-04NU	DM6S-04NU	T0403	TS0425	TU0425	
	DM6-06N	DM6P-06N	DM6S-06N	T0604	—	—	
	DM6-06NU	DM6P-06NU	DM6S-06NU	T0645	TS0604	TU0604	
12	DM12-04N	DM12P-04N	DM12S-04N	T0425	—	—	DM-C-12
	DM12-04NU	DM12P-04NU	DM12S-04NU	T0403	TS0425	TU0425	
	DM12-06N	DM12P-06N	DM12S-06N	T0604	—	—	
	DM12-06NU	DM12P-06NU	DM12S-06NU	T0645	TS0604	TU0604	

Specifications

Operating fluid	Air
Max. operating pressure	1.0MPa
Ambient and fluid temperature	-5 to 60°C (No freezing)

Component Materials

Socket case, Plug case, Clamp ring	ADC12 Black anodized
Plate	SPCC, Chromated
Holder	SPCC, Zinc chromated
Socket, Plug, Stopper	C3604BD
U packing	NBR
Cover	CR
Cross recessed head screw, Clamp bolt	SWRM Zinc chromated
Spacer	SPC Zinc chromated

Multi-connector *Series DM*

How to Use

⚠ Caution

Removing

Loosen clamp ring ①, and separate the multi-connector into two parts, socket side and plug side.

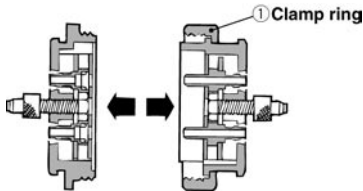

Insertion and removal of tube

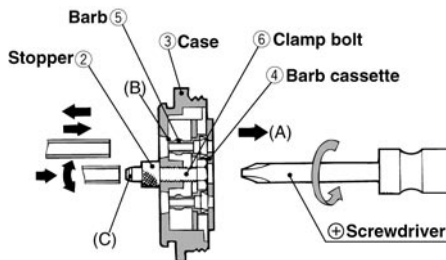

① Turn the clamp bolt ⑥ to the left with a screwdriver, loosen until the stopper ② touches the case ③, and barb cassette ④ will be pulled out in the direction (A). Then clamp portion (B), consisting of barb ⑤ and case ③, will be freed. Next, insert or remove the tube.

② The corresponding numbers are stamped on both the socket and plug sides for each tube connection.

③ If it is hard to insert the tube, enlarge the tube end with the head of stopper, expander (C), before inserting tube.

④ Insert tube until it clears mountain of barb ⑤ completely.

Clamping of tube

① After inserting tube, tighten clamp bolt ⑥ clockwise with a screwdriver.

② Barb cassette creeps into the direction (D) and the tube will be clamped at the (B) clamp portion ⑤ consisting of barb ③ and case.

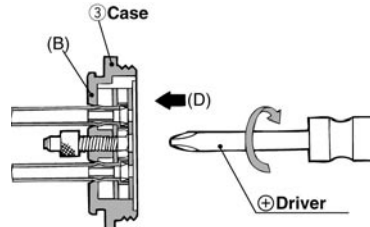

Connection

① Push together and rotate both of the cases, and the plug side will slide into the socket side at the proper position.

② The ring (E), male and female, of the plug side and socket side will interlock with each other at the proper position by pushing together and rotating.

③ Final process of connection is to screw-in the clamp ring.

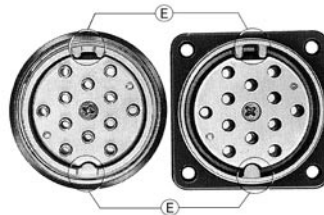

Cover mounting

① Cover is mountable on both sides, plug side and socket side.

② Enlarge cover and mount cover onto mounting area.

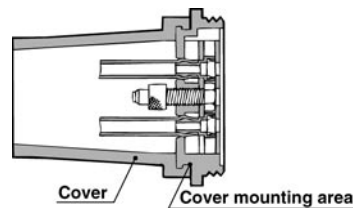

How to Order

DM 6 [] 04 N []

Number of connecting tubes

6	6
12	12

Style

—	Multi-connector
P	Plug side
S	Socket side

Tube O.D.

04	4mm
06	6mm

Accessories (optional)

C1	1 cover (One side)
C2	2 covers (Both sides)

Tube material

N	Nylon
NU	Soft nylon Polyurethane

Dimensions/DM6,12

DM6

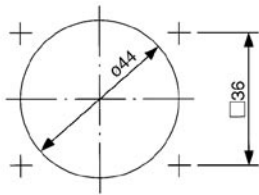

Panel mounting hole
(with the cover at socket side)

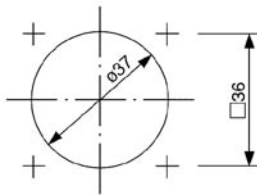

Panel mounting hole

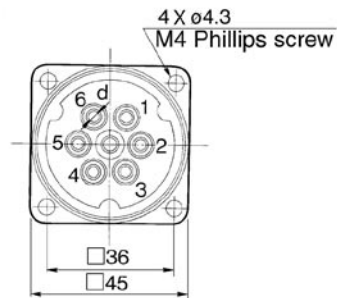
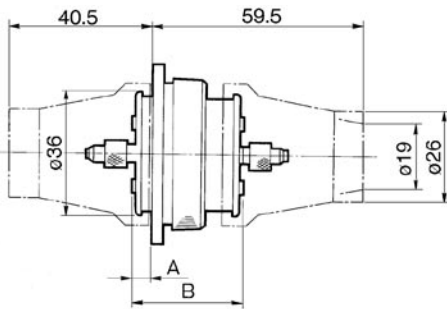

DM12

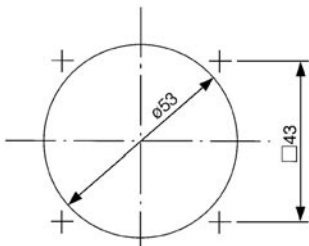

Panel mounting hole
(with the cover at socket side)

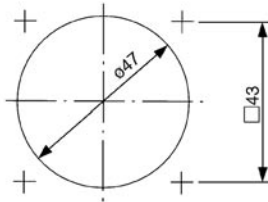

Panel mounting hole

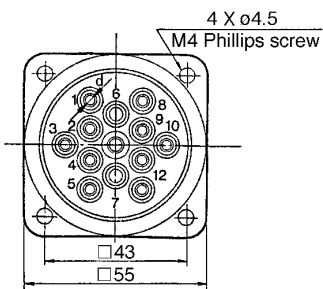
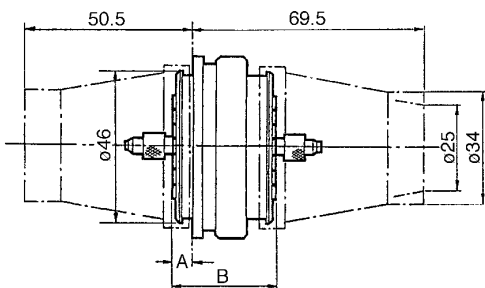

Part No.		Barb I.D. (d)	A	B
DM6-04N	DM12-04N	1.6	5	29
DM6-06N	DM12-06N	3		
DM6-04NU	DM12-04NU	1.6	6	31
DM6-06NU	DM12-06NU	3		

Precautions

Insertion of tube

Caution

- ① Be sure to insert the tube slowly so that you will feel it move smoothly and can feel it touch the end. Once the tube has been properly inserted, pull it back gently, to make sure that it has a positive seal. If not inserted properly, it may cause the air leakage or tube releasing.
- ② In case the number of tubes to be used is less than 6 (DM6) or 12 (DM12), the positioning of the tube should be symmetrical to the center.