

# Check Valve Series AK

High flow capacity

Low cracking pressure: **0.02MPa**

Compact and light weight

A wide variation of models

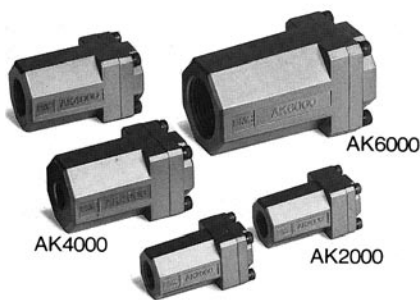

## Model

Model	Port size	Effective area (mm <sup>2</sup> )	Weight (g)
AK2000-01	1/8	25	105
AK2000-02	1/4	27.5	100
AK4000-02	1/4	47	155
AK4000-03	3/8	85	150
AK4000-04	1/2	95	140
AK6000-06	3/4	200	345
AK6000-10	1	230	315

## Specifications

Fluid	Air
Proof pressure	1.5MPa
Max.operating pressure	1MPa
Min.operating pressure	0.02MPa
Ambient and fluid temperature	-5 to 60°C(No freezing)

JIS Symbol

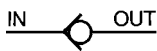

How to Order

**E AK 2 000 - 02**

Standard size

2	1/4
4	1/2
6	1

Thread

—	Rc(PT)
N	NPT
F	G(PF)

Port size

Port size	Applicable series
01	1/8 AK2000
02	1/4 AK2000, 4000
03	3/8 AK4000
04	1/2 AK4000
06	3/4 AK6000
10	1 AK6000

Ordering source area code

-	Japan, Asia Australia
E	Europe
N	North America

## Flow Characteristics

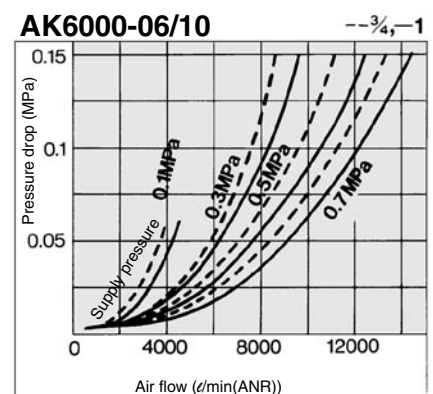
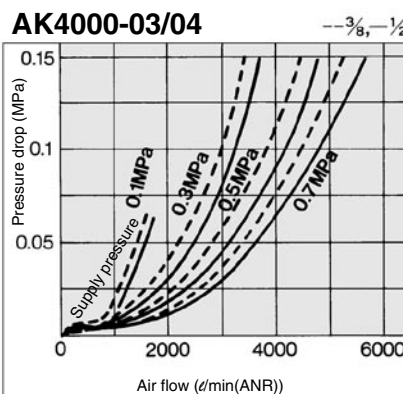
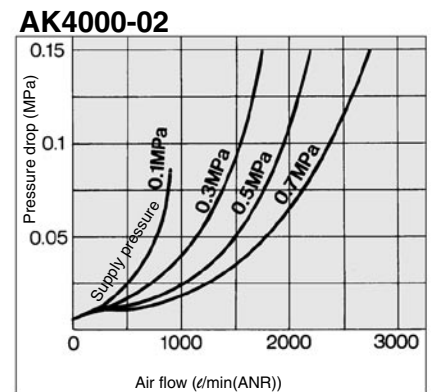
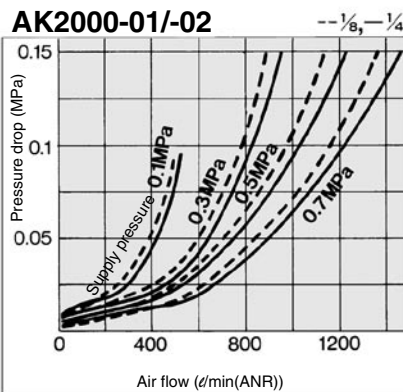

# Series AK

## Construction

AK2000

AK4000/6000

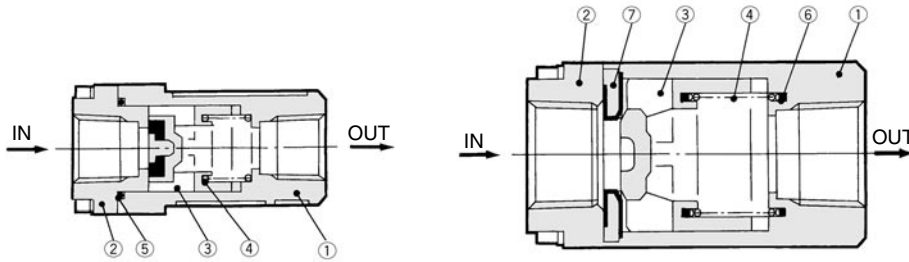

## Component parts

No.	Description	Material
①	Cover	Aluminum die casted <sup>(1)</sup>
②	Body	Aluminum die casted <sup>(1)</sup>

Note 1) AK2000: Zinc alloy

No.	Description	Material
③	Valve	POM
④	Spring	Stainless steel
⑤	O ring	NBR
⑥	Ring	NBR
⑦	Seat ring	Brass, NBR

## Dimensions

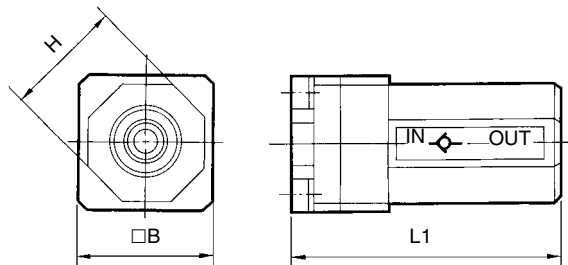

Model	Port size	L1	□B	H
AK2000-01, 02	1/8, 1/4	50	25	22
AK4000-02, 03, 04	1/4, 3/8, 1/2	67	36	36
AK6000-06, 10	3/4, 1	95	50	50