

Clean One-touch Fittings

Series *KP/KPQ/KPG*

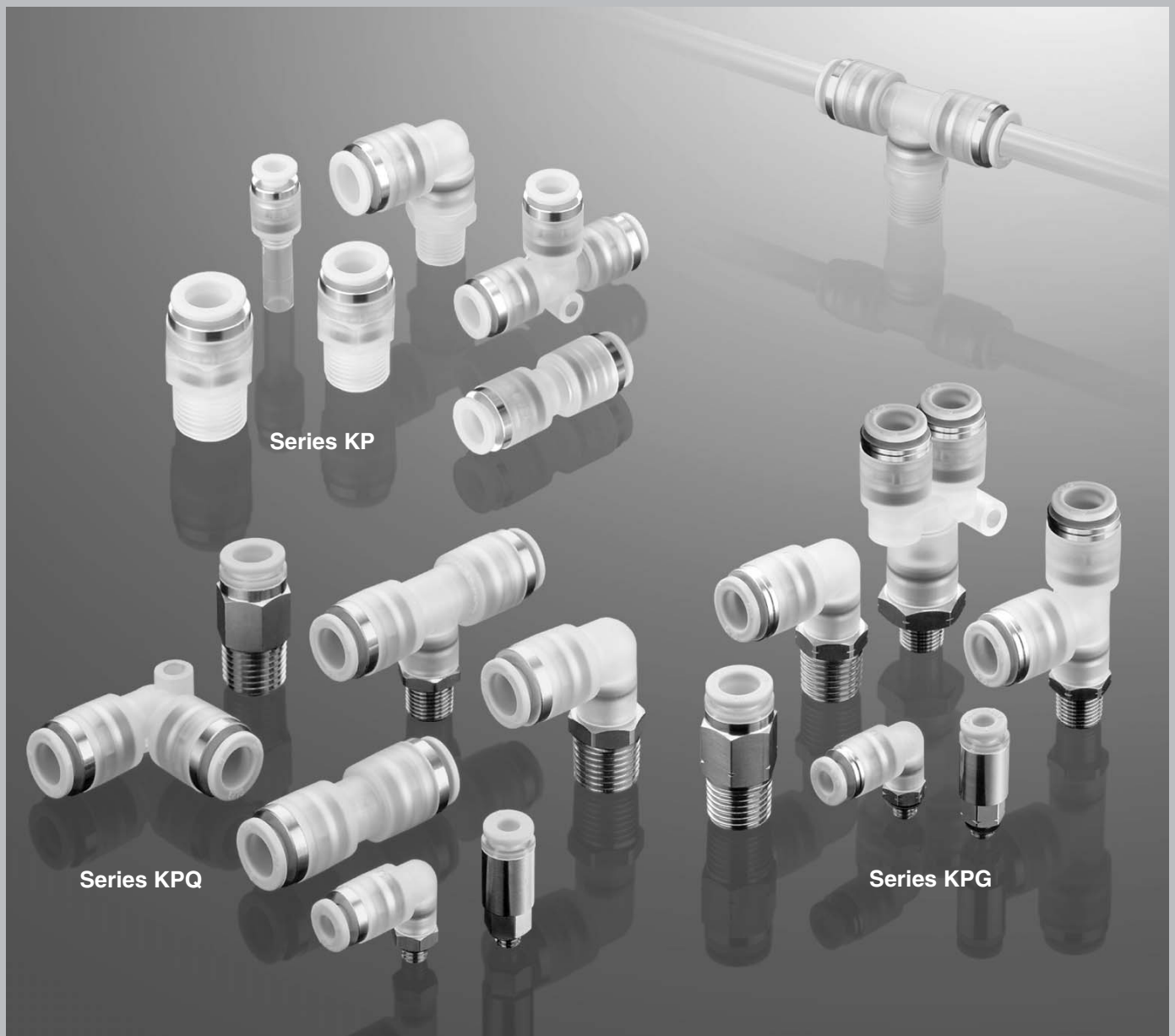

- K
- M
- H
- D
- MS
- T
- VMG

Series KPQ/KPG for drive system air piping added to Clean One-touch fitting Series KP

One-touch fittings and tubing for clean room blowing systems and drive air systems



Series KP

One-touch fittings (for blowing)

Series KP

- Completely oil free
- Liquid-contact areas are non-metallic
- Parts cleaning, assembly and double packaging in a clean room
- Can be used for vacuum (-100kPa)

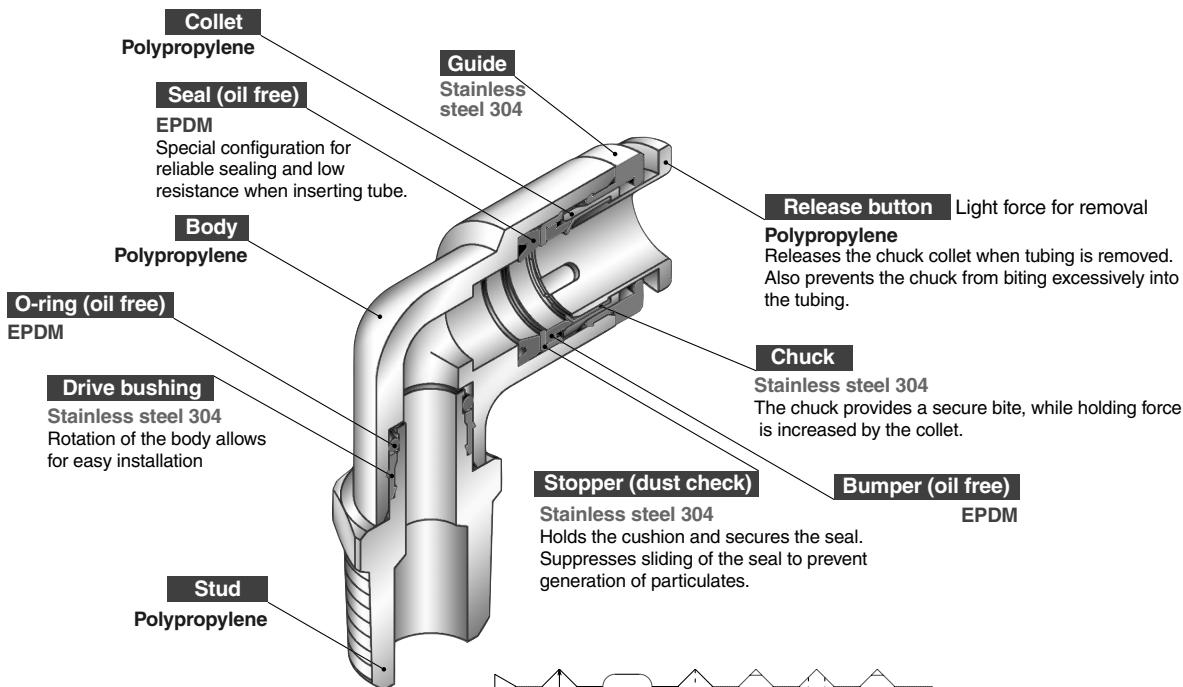

■ Clean blowing system

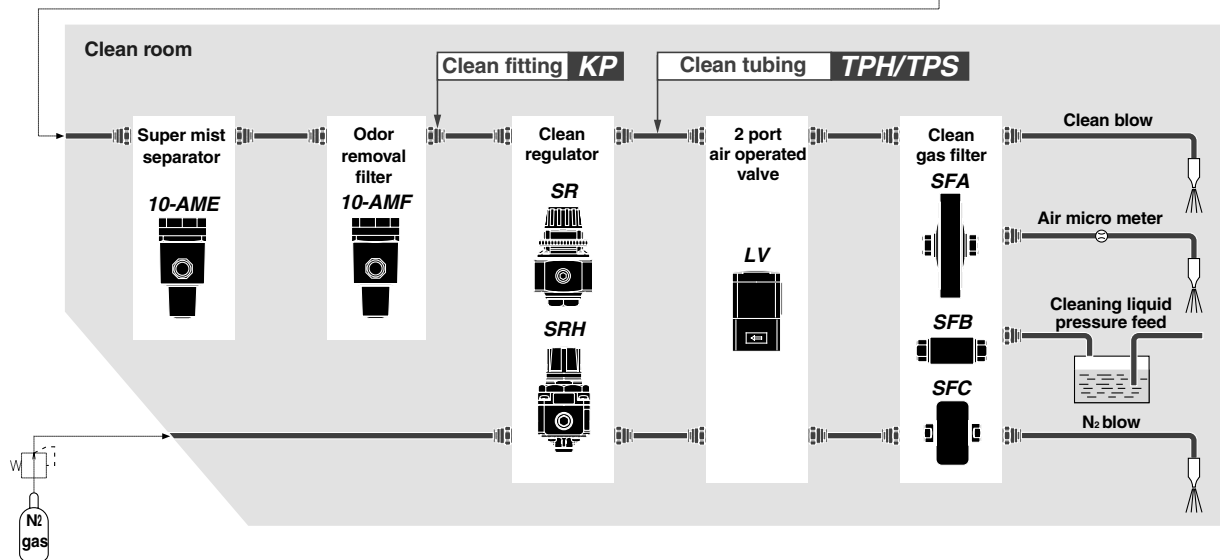



Low particulate generation

Clean performance



KPQ
Resin: PP
Metal: Brass (electroless nickel plated)



KPG
Resin: PP
Metal: Stainless steel 304



KP
Resin: PP
Metal: Stainless steel 304
★ Completely oil free/Liquid-contact parts resin

10-KQ2

Resin: PBT, POM
Metal: Brass (electroless nickel plated)

10-KG

Resin: PBT, POM
Metal: Stainless steel 303

Excellent

Environmental resistance

New

One-touch fittings (for drive system air piping)

Series KPQ/KPG

Brass (electroless nickel plated)

Stainless steel 304

- M5 size standardized
- Resin parts are P.P. (polypropylene)

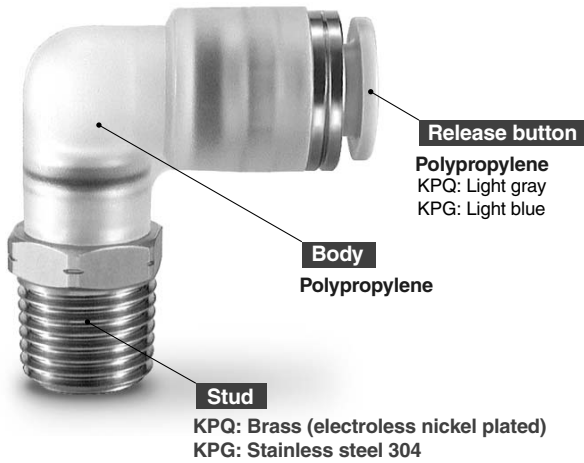

Series KPQ

Series KPG



Male connector

■ Drive air piping system

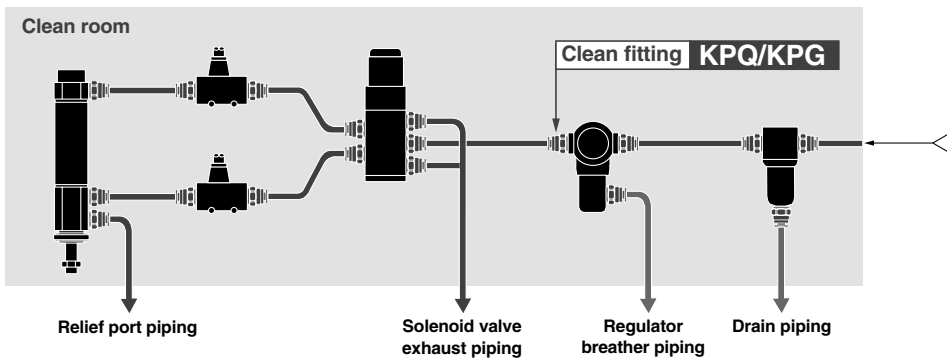

Polyolefin Tubing

Series TPH/TPS



Series	Material	Tubing O.D. mm					Color	Tubing length m
		4	6	8	10	12		
TPH	Polyolefin	●	●	●	●	●	White, Black Red, Blue	20
TPS	Soft Polyolefin	●	●	●	●	●	Yellow, Green	100

K□

M□

H□

D□

MS

T□

VMG

Clean One-touch Fittings For Blowing Series *KP*



⚠ Caution

Series KP is a line of special One-touch fittings for use in clean room blowing and washing lines. Please consult with SMC regarding other types of applications.

Seal material: The durability of EPDM with respect to mineral oils is inferior, which makes it unsuitable for piping in general pneumatic equipment.

Recommended Applicable Tubing

Tubing material	Polyolefin: Series TPH Soft polyolefin: Series TPS
Tubing O.D.	ø4, ø6, ø8, ø10, ø12

Note 1) Polyurethane tubing: Series TU, Nylon tubing: Series T, and Soft nylon tubing: Series TS can also be used. However, the degree of clean performance will be reduced.

Note 2) Due to the softness of polyurethane tubing, it may fold when being inserted. Hold the end of the tubing and insert it all the way in. Refer to "Installation and Removal of Tubing" on page 15.)

Specifications

Particulate generation grade	Grade 1 Note 1)
Fluid	Air/Nitrogen gas/Water (pure water) Note 2)
Maximum operating pressure (20°C)	1MPa Note 3)
Operating vacuum pressure	-100kPa
Proof pressure (20°C)	3MPa
Ambient and fluid temperature	-20°C to 80°C
Threads	JIS B0203 (Taper thread for piping)

Note 1) Refer to particulate generation grade classifications.

Note 2) Consult SMC regarding other fluids.

Note 3) The maximum operating pressure is the value at 20°C. Refer to the operating pressure curve for other temperatures.

Principal Parts Material

Body	Polypropylene resin
Stud	Polypropylene resin
Chuck	Stainless steel 304
Guide, Stopper, Drive bushing	Stainless steel 304
Collet, Release button	Polypropylene resin
Seal, O-ring, Bumper	EPDM

Particulate Generation Grade Classifications

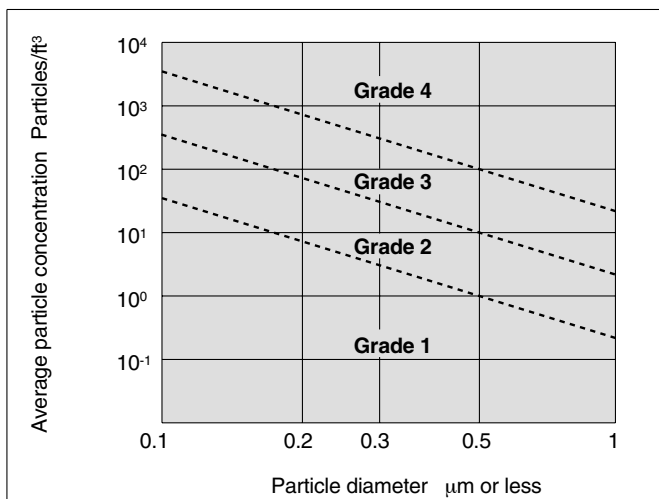

Relation between Operating Temperature and Maximum Operating Pressure

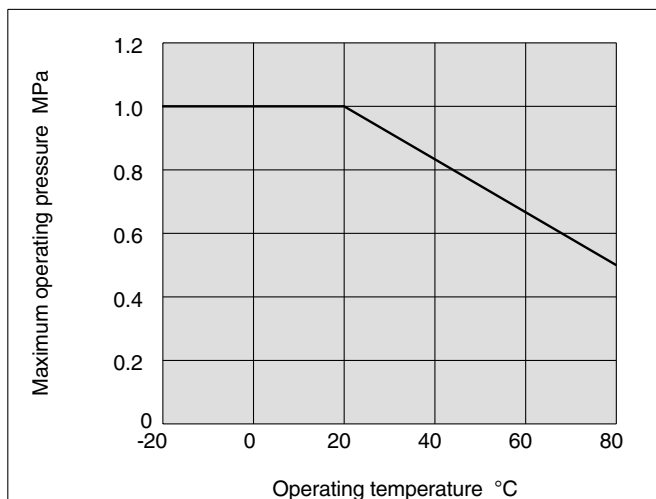

How to Order

Clean One-touch fittings (for blowing)

Model

H	Male connector, Straight union
L	Union elbow, Male elbow
T	Male branch tee, Union tee
Y	Male run tee
U	Male branch, Union "Y"
R	Plug-in reducer

Port size/Applicable tubing O.D.

Thread connection	01	R 1/8
	02	R 1/4
	03	R 3/8
	04	R 1/2
Tubing (rod) connection	00	Same dia. tubing
	04	ø4
	06	ø6
	08	ø8
	10	ø10
	12	ø12

Applicable tubing O.D.

04	ø4
06	ø6
08	ø8
10	ø10
12	ø12

Applicable fitting size

04	ø4
06	ø6
08	ø8
10	ø10
12	ø12

Plug

Clean One-touch fittings

KP H 06 01

KP P 08

- K
- M
- H
- D
- MS
- T
- VMG

Construction

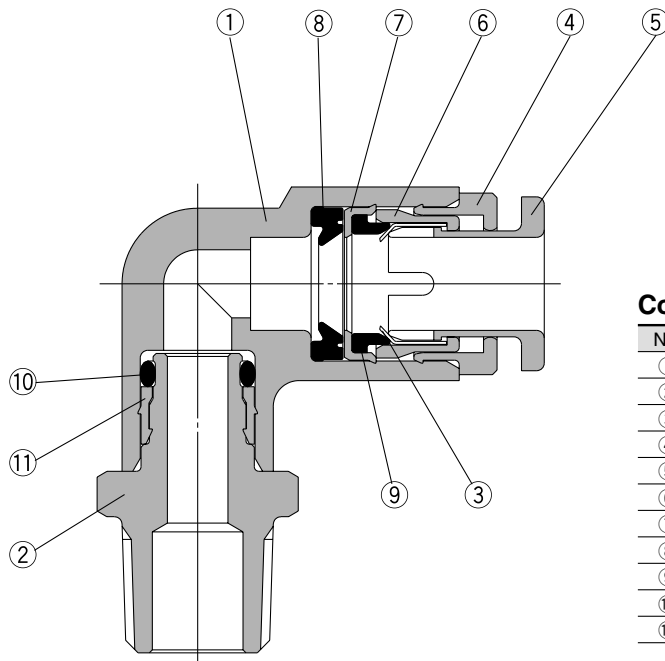

Component Parts

No.	Description	Material
①	Body	Polypropylene resin
②	Stud	Polypropylene resin
③	Chuck	Stainless steel 304
④	Guide	Stainless steel 304
⑤	Release button	Polypropylene resin (color: light green)
⑥	Collet	Polypropylene resin
⑦	Stopper	Stainless steel 304
⑧	Seal	EPDM
⑨	Bumper	EPDM
⑩	O-ring	EPDM
⑪	Drive bushing	Stainless steel 304

Series KP

Dimensions

Male Connector: KPH



Applicable tubing O.D. mm	Connection thread R	Model	H (width across flats)	L	A*	M	Effective area mm ²		Weight g
							TPH	TPS	
4	1/8	KPH04-01	12	25.4	21.5	18	4	4	3
	1/4	KPH04-02	14	25.4	19.5				4
6	1/8	KPH06-01	14	25.9	22	19.5	10	10	4
	1/4	KPH06-02	17	26.4	20.5				5
8	1/8	KPH08-01	17	32.3	28.5	21.5	26	18	6
	1/4	KPH08-02	19	30.3	24.5				7
10	1/4	KPH10-02	19	37.5	32	24	41	29	10
	3/8	KPH10-03	22	33	27				11
12	3/8	KPH12-03	22	34	28	25	58	46	12
	1/2	KPH12-04	27	34.5	27				13

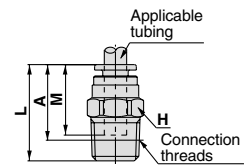

* Reference dimension for R threads after installation

Male Elbow: KPL



Applicable tubing O.D. mm	Connection thread R	Model	H (width across flats)	Note 1) ϕD_1	ϕD_2	L ₁	L ₂	A*	M	Effective area mm ²		Weight g
										TPH	TPS	
4	1/8	KPL04-01	12	10.4	10	20.7	23.2	24.5	18	3.5	3.5	4
	1/4	KPL04-02	14				27.2	26.5				5
6	1/8	KPL06-01	12	12.8	10	22.8	24.4	27	19.5	9	9	5
	1/4	KPL06-02	14				28.4	29				6
8	1/8	KPL08-01	14	15.2	12	26.3	26.6	30	21.5	22	15	8
	1/4	KPL08-02	17				29.4	31.5				9
10	1/4	KPL10-02	17	18.5	17	29.4	32.1	35.5	24	35	25	13
	3/8	KPL10-03	20				33.1	36.5				14
12	3/8	KPL12-03	20	20.9	22	31.4	34.3	38.5	25	50	40	15
	1/2	KPL12-04	27				38.3	41.5				18

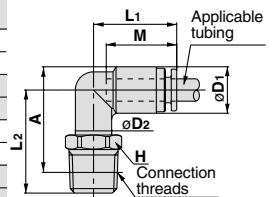

* Reference dimension for R threads after installation Note 1) ϕD_1 indicates the maximum diameter.

Male Branch Tee: KPT



Applicable tubing O.D. mm	Connection thread R	Model	H (width across flats)	Note 1) ϕD_1	ϕD_2	L ₁	L ₂	A*	M	Effective area mm ²		Weight g
										TPH	TPS	
4	1/8	KPT04-01	12	10.4	10	20.7	23.2	24.5	18	4.1	4.1	6
	1/4	KPT04-02	14				27.2	26.5				7
6	1/8	KPT06-01	12	12.8	10	22.8	24.4	27	19.5	11	11	8
	1/4	KPT06-02	14				28.4	29				9
8	1/8	KPT08-01	14	15.2	12	26.3	26.6	30	21.5	26.3	18.2	12
	1/4	KPT08-02	17				29.4	31.5				13
10	1/4	KPT10-02	17	18.5	17	29.4	32.1	35.5	24	40.8	29	20
	3/8	KPT10-03	20				33.1	36.5				21
12	3/8	KPT12-03	20	20.9	22	31.4	34.3	38.5	25	57.2	45.2	24
	1/2	KPT12-04	27				38.3	41.5				27

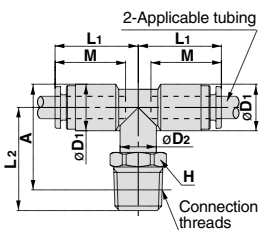

* Reference dimension for R threads after installation Note 1) ϕD_1 indicates the maximum diameter.

Male Run Tee: KPY



Applicable tubing O.D. mm	Connection thread R	Model	H (width across flats)	Note 1) ϕD_1	ϕD_2	L ₁	L ₂	A*	M	Effective area mm ²		Weight g
										TPH	TPS	
4	1/8	KPY04-01	12	10.4	10	20.7	23.2	40	18	7.5	7.5	6
	1/4	KPY04-02	14				27.2	42				7
6	1/8	KPY06-01	12	12.8	10	22.8	24.4	43	19.5	11	11	8
	1/4	KPY06-02	14				28.4	45.5				9
8	1/8	KPY08-01	14	15.2	12	26.3	26.6	49	21.5	21	21	12
	1/4	KPY08-02	17				29.4	50				13
10	1/4	KPY10-02	17	18.5	17	29.4	32.1	56	24	45	45	19
	3/8	KPY10-03	20				33.1	56.5				20
12	3/8	KPY12-03	20	20.9	22	31.4	34.3	59.5	25	57	57	21
	1/2	KPY12-04	27				38.3	62.5				24

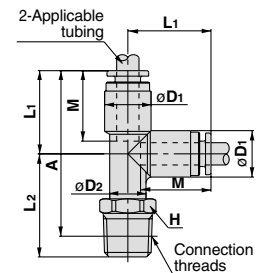

*Reference dimension for R threads after installation Note 1) ϕD_1 indicates the maximum diameter.

Male Branch "Y": KPU



Applicable tubing O.D. mm	Connection thread R	Model	H (width across flats)	Note 1) ϕD	L	P	A*	M	Effective area mm ²		Weight g
									TPH	TPS	
4	1/8	KPU04-01	12	10.4	45.4	10.4	41.5	18	7.5	7.5	7
	1/4	KPU04-02	14		49.4		43.5				8
6	1/8	KPU06-01	14	12.8	49.6	12.8	45.5	19.5	18	18	9
	1/4	KPU06-02	17		52.4		46.5				10
8	1/8	KPU08-01	17	15.2	56.7	15.2	52.5	21.5	26	26	15
	1/4	KPU08-02	19		61.3		55.5				17
10	1/4	KPU10-02	19	18.5	64.5	18.5	59	24	45	45	23
	3/8	KPU10-03	22		67.5		61.5				25
12	3/8	KPU12-03	22	20.9	69.7	20.9	63.5	25	70	70	29
	1/2	KPU12-04	27		72.7		65.5				30

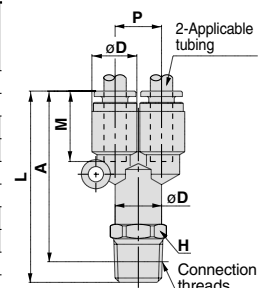

* Reference dimension for R threads after installation Note 1) ϕD indicates the maximum diameter.

Dimensions

Straight Union: KPH



Applicable tubing O.D. mm	Model	Note 1) ϕD	L	M	Effective area mm ²		Weight g
					TPH	TPS	
4	KPH04-00	10.4	37.4	18	4	4	4
6	KPH06-00	12.8	39.6	19.5	10	10	6
8	KPH08-00	15.2	44.4	21.5	26	18	10
10	KPH10-00	18.5	48.6	24	41	29	15
12	KPH12-00	20.9	50.6	25	58	46	18

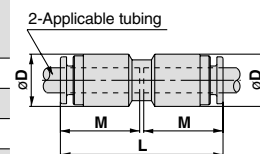

Note 1) ϕD indicates the maximum diameter.

Elbow: KPL



Applicable tubing O.D. mm	Model	Note 1) ϕD	L	Q	M	Effective area mm ²		Weight g
						TPH	TPS	
4	KPL04-00	10.4	20.7	4.5	18	3.5	3.5	3
6	KPL06-00	12.8	22.8	5.3	19.5	9	9	7
8	KPL08-00	15.2	26.3	6	21.5	22	15	11
10	KPL10-00	18.5	29.4	6.8	24	35	25	16
12	KPL12-00	20.9	31.4	7.5	25	50	40	20

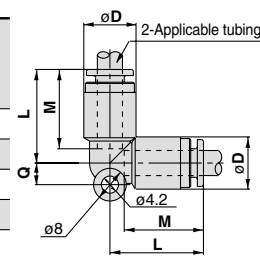

Note 1) ϕD indicates the maximum diameter.

Union Tee: KPT



Applicable tubing O.D. mm	Model	Note 1) ϕD	L	Q	M	Effective area mm ²		Weight g
						TPH	TPS	
4	KPT04-00	10.4	20.7	4.5	18	4	4	7
6	KPT06-00	12.8	22.8	5.3	19.5	10	10	9
8	KPT08-00	15.2	26.3	6	21.5	26	18	16
10	KPT10-00	18.5	29.4	6.8	24	41	29	25
12	KPT12-00	20.9	31.4	7.5	25	58	46	29

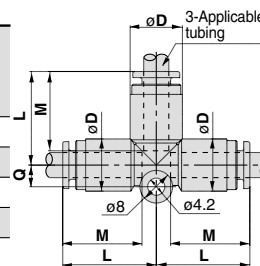

Note 1) ϕD indicates the maximum diameter.

Union "Y": KPU



Applicable tubing O.D. mm	Model	Note 1) ϕD	L ₁	L ₂	P	Q	M	Effective area mm ²		Weight g
								TPH	TPS	
4	KPU04-00	10.4	38.8	20.6	10.4	9.7	18	4	4	7
6	KPU06-00	12.8	42.1	22.8	12.8	11.7	19.5	10	10	10
8	KPU08-00	15.2	48.7	27.5	15.2	13.7	21.5	26	18	17
10	KPU10-00	18.5	54	30.7	18.5	16.1	24	41	29	26
12	KPU12-00	20.9	57.2	32.9	20.9	18.1	25	58	46	32

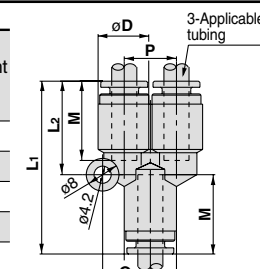

Note 1) ϕD indicates the maximum diameter.

Plug-in Reducer: KPR



Applicable tubing O.D. mm	Applicable fitting size ϕd	Model	Note 1) ϕD	L	A	M	Effective area mm ²		Weight g
							TPH	TPS	
4	6	KPR04-06	10.4	39.4	20.1	18	4	4	3
	8	KPR04-08		41.9	20.2				4
6	10	KPR06-08	12.8	42.5	20.8	19.5	10	10	4
		KPR06-10		45	21.2				5
8	12	KPR08-10	15.2	47	23.2	21.5	26	18	5
		KPR08-12		48	23.2				6
10		KPR10-12	18.5	50.5	25.7	24	41	29	9

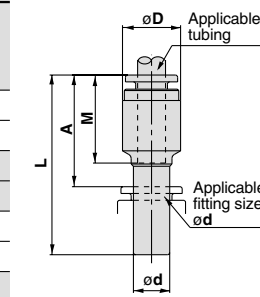

Note 1) ϕD indicates the maximum diameter.

Plug: KPP



Applicable fitting size ϕd	Model	ϕD	L	A	Weight g
4	KPP-04	6	32	13.8	0.4
6	KPP-06	8	35	15.7	0.7
8	KPP-08	10	39	17.3	1.1
10	KPP-10	12	43	19.2	1.7
12	KPP-12	14	45.5	20.7	2.5

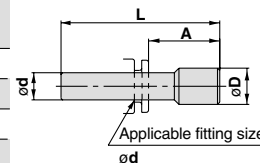

K□

M□

H□

D□

MS

T□

VMG

Clean One-touch Fittings For Drive System Air Piping Series **KPQ/KPG**



Series KPQ
Brass (electroless nickel plated)
Release button: Light gray



Series KPG
Stainless steel 304
Release button: Light blue

Recommended Applicable Tubing

Tubing material	Polyurethane: 10-series
Tubing O.D.	ø4, ø6, ø8, ø10, ø12

Polyurethane tubing: Series TU, Nylon tubing: Series T, and Soft nylon tubing: Series TS can also be used. However, the degree of clean performance will be reduced.

Specifications

Particulate generation grade	Grade 1 Note 1)
Fluid	Air
Maximum operating pressure (20°C)	1MPa Note 2)
Operating vacuum pressure	-100kPa
Proof pressure (20°C)	3MPa
Ambient and fluid temperature	-5°C to 60°C
Threads	JIS B0203 (Taper thread for piping)

Note 1) Refer to particulate generation grade classifications

This falls outside of the grade because grease is applied to the internal seal materials.

Note 2) The maximum operating pressure is the value at 20°C. Refer to the operating pressure curve for other temperatures.

Principal Parts Material

Model	Series KPQ	Series KPG
Body	Polypropylene resin	
Stud	Brass (Electroless nickel plated)	Stainless steel 304
Chuck	Stainless steel 304	
Guide, Stopper	Brass (Electroless nickel plated)	Stainless steel 304
Collet, Release button	Polypropylene resin	
Seal, O-ring, Bumper	NBR	

Particulate Generation Grade Classifications

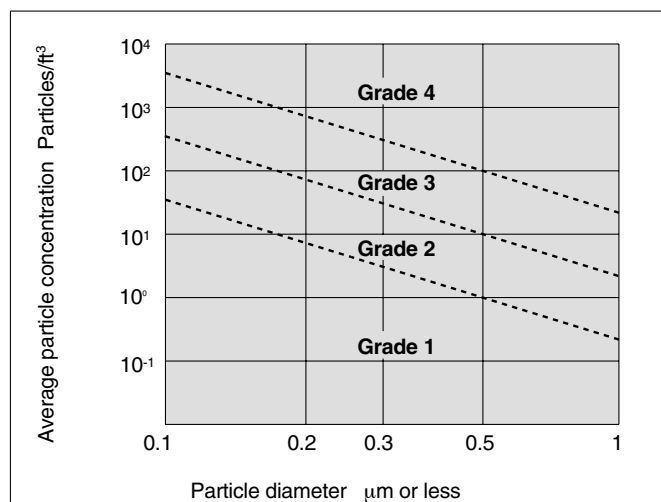

Relation between Operating Temperature and Maximum Operating Pressure

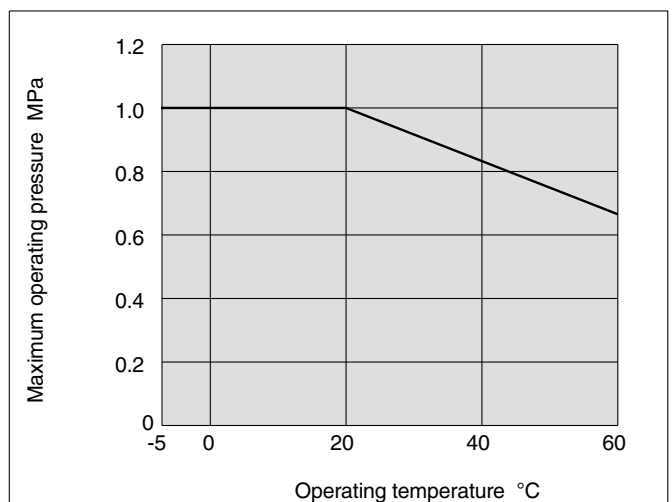

How to Order

Clean One-touch fittings

Specifications

Symbol	Specifications (metal part materials)
Q	Brass (electroless nickel plated)
G	Stainless steel 304

Model

H	Male connector, Straight union
L	Union elbow, Male elbow
T	Male branch tee, Union tee
Y	Male run tee
U	Male branch, Union "Y"
R	Plug-in reducer

Port size/Applicable tubing O.D.

Thread connection	Applicable tubing O.D.	
	Symbol	Size
M5		M5 x 0.8
01		R 1/8
02		R 1/4
03		R 3/8
04		R 1/2

Applicable tubing O.D.

04	ø4
06	ø6
08	ø8
10	ø10
12	ø12

Thread connection

Tubing (rod) connection	Applicable tubing O.D.	
	Symbol	Size
00		Same dia. tubing
04		ø4
06		ø6
08		ø8
10		ø10
12		ø12

Different dia. tubing (plug-in reducer)

Applicable fitting size

04	ø4
06	ø6
08	ø8
10	ø10
12	ø12

Plug

Clean One-touch fittings

Legend: K□, M□, H□, D□, MS, T□, VMG

Construction

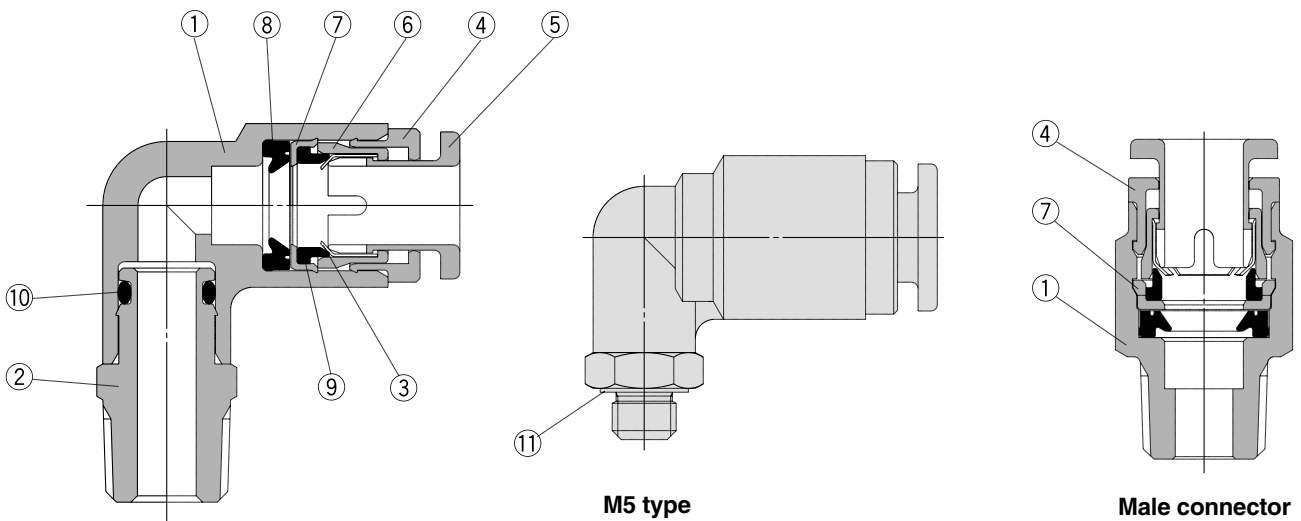

Component Parts

No.	Description	Material	
		Series KPQ	Series KPG
①	Body	Polypropylene resin	
		With male connector	Brass (electroless nickel plated)
②	Stud	Brass (electroless nickel plated)	Stainless steel 304
③	Chuck	Stainless steel 304	
④	Guide	Brass (electroless nickel plated)	
		With male connector	Polypropylene resin
⑤	Release button	Polypropylene resin (color: light gray)	Polypropylene resin (color: light blue)
⑥	Collet	Polypropylene resin	
⑦	Stopper	Stainless steel 304	
		With male connector	Polypropylene resin
⑧	Seal	NBR	
⑨	Bumper	NBR	
⑩	O-ring	NBR	
⑪	Gasket	Stainless steel 304 + NBR	

Series KP/KPG

Dimensions

Male Connector: KPQH, KPGH

(M5)



(R)



Applicable tubing O.D. mm	Connection thread R	Model		H (width across flats)	øD	L	A*	M	Effective area mm ²		Weight g
		TPH	TPS								
4	M5	KPQH04-M5	—	8	10	25.4	22.5	18	4	4	4
		—	KPGH04-M5			25.9					
	1/8	KPQH04-01	KPGH04-01	10	—	25.4	19.5		7		
		1/4	KPQH04-02	KPGH04-02	14	—	22.9		17	12	
6	M5	KPQH06-M5	—	8	12	26.3	23	19.5	10	10	5
		—	KPGH06-M5			26.8					
	1/8	KPQH06-01	KPGH06-01	12	—	25.6	19.5		7		
		1/4	KPQH06-02	KPGH06-02	14	—	26.1		20	14	
8	1/8	KPQH08-01	KPGH08-01	14	—	32.6	26.5	21.5	26	18	14
	1/4	KPQH08-02	KPGH08-02		—	30.6	24.5				13
10	1/4	KPQH10-02	KPGH10-02	17	—	37.6	31.5	24	41	29	24
	3/8	KPQH10-03	KPGH10-03		—	33	26.5				23
12	3/8	KPQH12-03	KPGH12-03	19	—	34.1	27.5	25	58	46	23
	1/2	KPQH12-04	KPGH12-04		—	34.1	26				46

* Reference dimension for R threads after installation

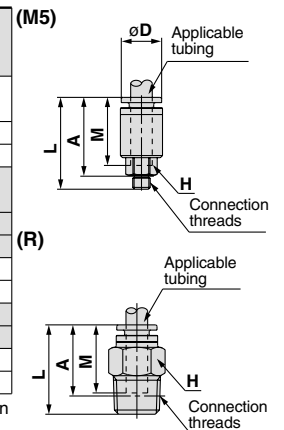

Male Elbow: KPQL, KPGL

(M5)



(R)



Applicable tubing O.D. mm	Connection thread R	Model		H (width across flats)	Note 1) øD ₁	øD ₂	L ₁	L ₂	A*	M	Effective area mm ²		Weight g			
		TPH	TPS													
4	M5	KPQL04-M5	KPGL04-M5	8	10.4	8	20.7	15.3	17	18	4	4	4			
	1/8	KPQL04-01	KPGL04-01	10										22	21	10
	1/4	KPQL04-02	KPGL04-02	14										26	25	19
6	M5	KPQL06-M5	KPGL06-M5	8	12.8	8	22.8	15.8	18.5	19.5	10	10	6			
	1/8	KPQL06-01	KPGL06-01	10										23.2	23.5	12
	1/4	KPQL06-02	KPGL06-02	14										27.2	27.5	20
8	1/8	KPQL08-01	KPGL08-01	12	15.2	12	26.3	24.4	26	21.5	26	18	13			
	1/4	KPQL08-02	KPGL08-02										14	28.4	30	21
10	1/4	KPQL10-02	KPGL10-02	17	18.5	17	29.4	29.9	33	24	41	29	26			
	3/8	KPQL10-03	KPGL10-03										17	31.9	34.5	36
	3/8	KPQL12-03	KPGL12-03										17	33.1	37	38
12	1/2	KPQL12-04	KPGL12-04	22	20.9	—	31.4	37.1	39.5	25	58	46	65			

* Reference dimension for R threads after installation Note 1) øD₁ indicates the maximum diameter.

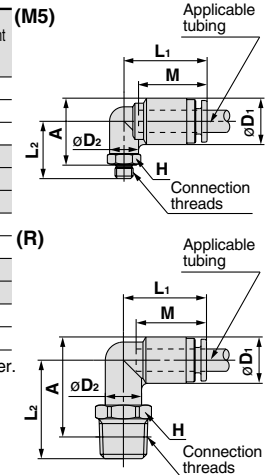

Union Tee: KPQT, KPQT

(M5)



(R)



Applicable tubing O.D. mm	Connection thread R	Model		H (width across flats)	Note 1) øD ₁	øD ₂	L ₁	L ₂	A*	M	Effective area mm ²		Weight g			
		TPH	TPS													
4	M5	KPQT04-M5	KPGT04-M5	8	10.4	8	20.7	15.3	17	18	4	4	6			
	1/8	KPQT04-01	KPGT04-01	10										22	21	13
	1/4	KPQT04-02	KPGT04-02	14										26	25	19
6	M5	KPQT06-M5	KPGT06-M5	8	12.8	8	22.8	15.8	18.5	19.5	10	10	7			
	1/8	KPQT06-01	KPGT06-01	10										23.2	23.5	14
	1/4	KPQT06-02	KPGT06-02	14										27.2	27.5	20
8	1/8	KPQT08-01	KPGT08-01	12	15.2	12	26.3	24.4	26	21.5	26	18	14			
	1/4	KPQT08-02	KPGT08-02										14	28.4	30	22
10	1/4	KPQT10-02	KPGT10-02	17	18.5	17	29.4	29.9	33	24	41	29	29			
	3/8	KPQT10-03	KPGT10-03										17	31.9	34.5	39
	3/8	KPQT12-03	KPGT12-03										17	33.1	37	41
12	1/2	KPQT12-04	KPGT12-04	22	20.9	—	31.4	37.1	39.5	25	58	46	38			

* Reference dimension for R threads after installation Note 1) øD₁ indicates the maximum diameter.

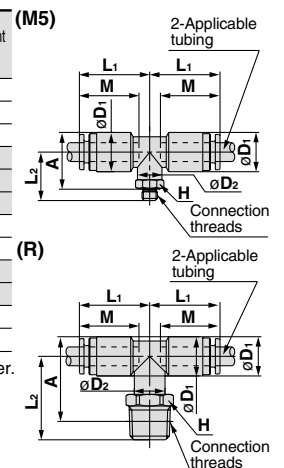

Dimensions

Male Run Tee: KPQY, KPGY

(M5)



Applicable tubing O.D. mm	Connection thread R	Model		H (width across flats)	Note 1) ϕD_1	ϕD_2	L ₁	L ₂	A*	M	Effective area mm ²		Weight g
		TPH	TPS										
4	M5	KPQY04-M5	KPGY04-M5	8	10.4	8	20.7	15.3	32.5	18	4	4	6
	1/8	KPQY04-01	KPGY04-01	10		22		36.5	13				
	1/4	KPQY04-02	KPGY04-02	14		26		40.5	19				
6	M5	KPQY06-M5	KPGY06-M5	8	12.8	8	22.8	15.8	35	19.5	10	10	7
	1/8	KPQY06-01	KPGY06-01	10		23.2		40	14				
	1/4	KPQY06-02	KPGY06-02	14		27.2		44	20				
8	1/8	KPQY08-01	KPGY08-01	12	15.2	12	26.3	24.4	44.5	21.5	26	18	14
	1/4	KPQY08-02	KPGY08-02	14				28.4	48.5				22
10	1/4	KPQY10-02	KPGY10-02	17	18.5	17	29.4	29.9	53.5	24	41	29	29
	3/8	KPQY10-03	KPGY10-03					31.9	55				39
	3/8	KPQY12-03	KPGY12-03					33.1	58				41
12	1/2	KPQY12-04	KPGY12-04	22	20.9	17	31.4	37.1	60.5	25	58	46	68

* Reference dimension for R threads after installation Note 1) ϕD_1 indicates the maximum diameter.

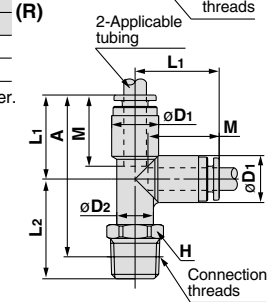
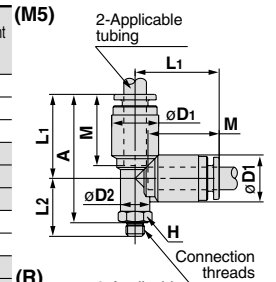

Male Branch: KPQU, KPGU

(M5)



Applicable tubing O.D. mm	Connection thread R	Model		H (width across flats)	Note 1) ϕD	L	P	A*	M	Effective area mm ²		Weight g
		TPH	TPS									
4	M5	KPQU04-M5	KPGU04-M5	11	10.4	41.7	10.4	38	18	4	4	10
	1/8	KPQU04-01	KPGU04-01			44.2		38				11
	1/4	KPQU04-02	KPGU04-02			48.2		42				20
6	M5	KPQU06-M5	KPGU06-M5	13	12.8	44.9	12.8	41.5	19.5	10	10	12
	1/8	KPQU06-01	KPGU06-01			47.4		41.5				11
	1/4	KPQU06-02	KPGU06-02			51.4		45.5				21
8	1/8	KPQU08-01	KPGU08-01	17	15.2	55.5	15.2	49.5	21.5	26	18	15
	1/4	KPQU08-02	KPGU08-02			60.6		54.5				23
10	1/4	KPQU10-02	KPGU10-02	19	18.5	63.8	18.5	58	24	41	29	30
	3/8	KPQU10-03	KPGU10-03			61.3		55				40
	3/8	KPQU12-03	KPGU12-03			67		60.5				40
12	1/2	KPQU12-04	KPGU12-04	22	20.9	71.4	20.9	63.5	25	58	46	65

* Reference dimension for R threads after installation Note 1) ϕD indicates the maximum diameter.

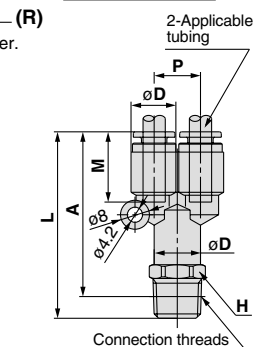
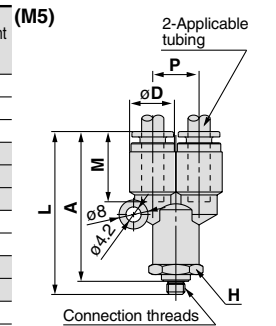

Straight Union: KPQH, KPGH



Applicable tubing O.D. mm	Model		Note 1) ϕD	L	M	Effective area mm ²		Weight g
	TPH	TPS						
4	KPQH04-00	KPGH04-00	10.4	37.4	18	4	4	4
6	KPQH06-00	KPGH06-00	12.8	39.6	19.5	10	10	6
8	KPQH08-00	KPGH08-00	15.2	44.4	21.5	26	18	10
10	KPQH10-00	KPGH10-00	18.5	48.6	24	41	29	15
12	KPQH12-00	KPGH12-00	20.9	50.6	25	58	46	18

Note 1) ϕD indicates the maximum diameter.

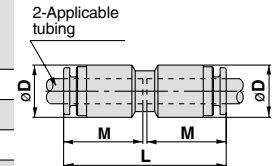

Series KP/KPG

Elbow: KPQL, KPGL



Applicable tubing O.D. mm	Model		Note 1) ϕD	L	Q	M	Effective area mm ²		Weight g
							TPH	TPS	
4	KPQL04-00	KPGL04-00	10.4	20.7	4.5	18	3.5	3.5	3
6	KPQL06-00	KPGL06-00	12.8	22.8	5.3	19.5	9	9	7
8	KPQL08-00	KPGL08-00	15.2	26.3	6	21.5	22	15	11
10	KPQL10-00	KPGL10-00	18.5	29.4	6.8	24	35	25	16
12	KPQL12-00	KPGL12-00	20.9	31.4	7.5	25	50	40	20

Note 1) ϕD indicates the maximum diameter.

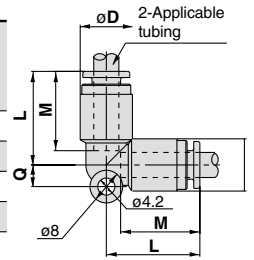

Union Tee: KPQT, KPGT



Applicable tubing O.D. mm	Model		Note 1) ϕD	L	Q	M	Effective area mm ²		Weight g
							TPH	TPS	
4	KPQT04-00	KPGT04-00	10.4	20.7	4.5	18	4	4	7
6	KPQT06-00	KPGT06-00	12.8	22.8	5.3	19.5	10	10	9
8	KPQT08-00	KPGT08-00	15.2	26.3	6	21.5	26	18	16
10	KPQT10-00	KPGT10-00	18.5	29.4	6.8	24	41	29	25
12	KPQT12-00	KPGT12-00	20.9	31.4	7.5	25	58	46	29

Note 1) ϕD indicates the maximum diameter.

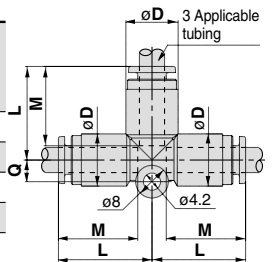

Union "Y": KPQU, KPQU



Applicable tubing O.D. mm	Model		Note 1) ϕD	L ₁	L ₂	P	Q	M	Effective area mm ²		Weight g
									TPH	TPS	
4	KPQU04-00	KPGU04-00	10.4	38.8	20.6	10.4	9.7	18	4	4	7
6	KPQU06-00	KPGU06-00	12.8	42.1	22.8	12.8	11.7	19.5	10	10	10
8	KPQU08-00	KPGU08-00	15.2	48.7	27.5	15.2	13.7	21.5	26	18	17
10	KPQU10-00	KPGU10-00	18.5	54	30.7	18.5	16.1	24	41	29	26
12	KPQU12-00	KPGU12-00	20.9	57.2	32.9	20.9	18.1	25	58	46	32

Note 1) ϕD indicates the maximum diameter.

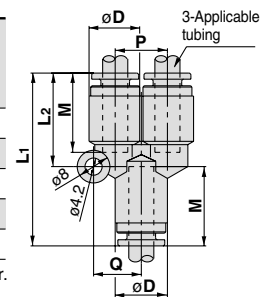

Plug-in Reducer: KPQR, KPGR



Applicable tubing O.D. mm	Applicable fitting size ϕd	Model		Note 1) ϕD	L	A	M	Effective area mm ²		Weight g
								TPH	TPS	
4	6	KPQR04-06	KPGR04-06	10.4	39.4	20.1	18	4	4	3
		KPQR04-08	KPGR04-08		41.9	20.2				
6	8	KPQR06-08	KPGR06-08	12.8	42.5	20.8	19.5	10	10	4
		KPQR06-10	KPGR06-10		45	21.2				
8	10	KPQR08-10	KPGR08-10	15.2	47	23.2	21.5	26	18	5
		KPQR08-12	KPGR08-12		48	23.2				
10	12	KPQR10-12	KPGR10-12	18.5	50.5	25.7	24	41	29	9

Note 1) ϕD indicates the maximum diameter.

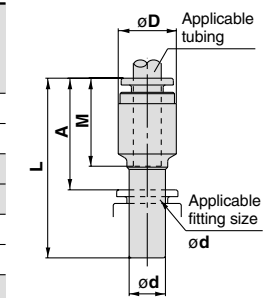

Plug: KPP



Applicable fitting size ϕd	Model	ϕD	L	A	Weight g
4	KPP-04	6	32	13.8	0.4
6	KPP-06	8	35	15.7	0.7
8	KPP-08	10	39	17.3	1.1
10	KPP-10	12	43	19.2	1.7
12	KPP-12	14	45.5	20.7	2.5

* The plug is common for series KPQ, KPG and KP.

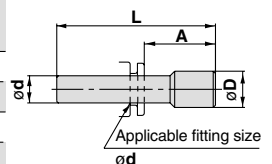



Series KP/KPQ/KPG

Specific Product Precautions 1

Be sure to read before handling.

Selection

⚠ Caution

1. Do not use in locations where the connecting threads and tubing connection will slide or rotate. The connecting threads and tubing connection will come apart under these conditions.
2. Use tubing at or above the minimum bending radius. Using below the minimum bending radius can cause breakage or flattening of the tube.
3. Please consult with SMC regarding fluids other than air, water and nitrogen gas.
4. In the case of liquid fluids, keep surge pressure at or below the maximum operating pressure. If the surge pressure exceeds the maximum operating pressure, this can cause damage to the fittings and tubing.

Handling

⚠ Caution

1. Store away from direct sunlight at 40°C or less.
2. Open the inner package of double packaging in a clean room or other clean environment.

Mounting

⚠ Caution

1. Before mounting confirm the model and size, etc. Also, confirm that there are no blemishes, nicks or cracks in the product.
2. When tubing is connected, consider factors such as changes in the tubing length due to pressure, and allow sufficient leeway.
3. Mount so that fittings and tubing are not subjected to twisting, pulling or moment loads. This can cause damage to fittings and flattening, bursting or disconnection of tubing, etc.
4. Mount so that tubing is not damaged due to tangling and abrasion. This can cause flattening, bursting or disconnection of tubing, etc.

Installation of Threads

⚠ Caution

Be sure to wrap sealing tape around the taper threads for both resin and metal threads.

If used without sealing tape air leakage can occur.

1. Series KP (with resin thread)
 - 1) Wrapping of pipe tape
Wrap the pipe tape 2 to 3 times around the threads, leaving 1.5 to 2 thread ridges exposed at the end of the threads.
 - 2) Tightening
After tightening by hand, tighten an additional 2 to 3 turns using a tightening tool.

Installation of Threads

⚠ Caution

2. Series KPQ/KPG (with metal thread)
 - 1) For M5
After tightening by hand, tighten approximately 1/6 turn further using a tightening tool. Excessive tightening can cause air leakage due to thread damage or deformation of the gasket, etc. Insufficient tightening can cause loose threads and air leakage, etc.
 - 2) Taper thread
 - (1) Wrapping of pipe tape
Wrap the pipe tape 2 to 3 times around the threads, leaving 1.5 to 2 thread ridges exposed at the end of the threads.
 - (2) When installing, tighten with the proper torque shown in the table below. As a rule, this corresponds to two or three turns with a tool after tightening by hand.

Connection thread size	Proper tightening torque
R 1/8	7 to 9
R 1/4	12 to 14
R 3/8	22 to 24
R 1/2	28 to 30

3. Tightening tools
Tighten with an appropriate wrench using the hexagon wrench flats on the body.
Position the wrench on the base as close as possible to the threads. If the size of the wrench is not suitable for the hexagon wrench flats, the wrench flats may be crushed.

Installation and Removal of Tubing

⚠ Caution

1. Installation of tubing
 - 1) Using tube cutters TK-1, 2 or 3, take a tube having no flaws on its periphery and cut it off at a right angle. Do not use pinchers, nippers or scissors, etc. The tubing might be cut diagonally or flattened, making installation impossible or causing problems such as disconnection and leakage.
 - 2) Hold the tube and push it in slowly, inserting it securely all the way into the fitting.
 - 3) After inserting the tubing, pull on it lightly to confirm that it will not come out. If it is not installed securely all the way into the fitting, problems such as leakage or disconnection of the tubing can occur.
 - 4) Grease is not used due to the Series KP oil-free specifications. For this reason, greater insertion force is required when tubing is installed. In particular, polyurethane tubing may fold when inserted due to its softness. Hold the end of the tubing, and insert it all the way in slowly and securely. Refer to dimension "M" in the dimension drawings for guidance on the insertion depth of tubing.

K□

M□

H□

D□

MS

T□

VMG



Series KP/KPQ/KPG

Specific Product Precautions 2

Be sure to read before handling.

Installation and Removal of Tubing

Caution

2. Removal of tubing
 - 1) Push in the release button sufficiently, pressing the collar evenly around its circumference.
 - 2) Pull out the tubing while holding down the release button so that it does not pop out. If the release button is not pressed down sufficiently, there will be increased bite on the tubing and it will become more difficult to pull it out.
 - 3) When the removed tubing is to be used again, first cut off the section of the tubing which has been chewed. Using the chewed portion of the tube as it is can cause problems such as leakage or difficulty in removing the tubing.

Operating Environment

Warning

1. Do not use in environments or locations where there is a danger of damage to fittings and tubing.
For fitting and tubing materials, refer to specifications and construction drawings, etc.
2. Provide shade in locations which receive direct sunlight.
3. Do not operate in locations where vibration or impact occurs.
Since this can cause leakage and fitting damage, etc., please contact SMC regarding use in this kind of environment.
4. Provide shielding in locations near heat sources.
When there are heat sources in the surrounding area, the product's temperature may rise due to radiated heat and exceed its operating temperature range. Block off the heat with a cover, etc.
5. Do not use in locations where static electric charges will be a problem. Please consult with SMC regarding use in this kind of environment.
6. Do not use in locations where spatter occurs.
There is a danger of spatter causing a fire. Please consult with SMC regarding use in this kind of environment.

Caution

1. Series KP are special One-touch fittings for use on clean blowing and washing lines. Please consult with SMC regarding other types of applications.
Seal material: The durability of EPDM with respect to mineral oils is inferior, making it unsuitable for piping in general pneumatic equipment.
Use Series KPQ and KPG for piping to general pneumatic equipment.

Maintenance

Caution

1. Pre-maintenance inspection
When the product is to be removed, turn off the electric power, and be sure to cut off the supply pressure and confirm that fluid in the piping has been discharged.
2. Post maintenance inspection
After remounting and connection of piping, restore the fluid and electric power, and perform suitable function and leak tests. If leakage occurs or the equipment does not operate properly, stop operation immediately and confirm whether it is mounted correctly.
3. Tightening of blow fittings (resin taper threads for piping)
Since Series KP taper threads are made of resin, minute leakage may gradually occur due to stress relaxation. Perform periodic inspections, and if leakage is detected correct the problem by further tightening. If additional tightening becomes ineffective, replace the fitting with a new product.
4. Check for the following during regular maintenance, and replace components as necessary.
 - a) Scratches, gouges, abrasion, corrosion
 - b) Leakage, refer to item 3 regarding taper thread leakage.
 - c) Twisting, flattening or distortion of tubing
 - d) Hardening, deterioration or softness of tubing
5. Do not repair or patch the replaced tubing or fittings for reuse.

Precaution on Use of Other Tubing Brands

Caution

1. When using tubing brands other than SMC, confirm that the tubing outside diameter tolerances satisfy the following specifications.

1) Polyolefin tubing	±0.1 mm
2) Polyurethane tubing	+0.15 mm -0.2 mm
3) Nylon tubing	±0.1 mm
4) Soft nylon tubing	±0.1 mm

Do not use tubing if the outside diameter tolerance is not satisfied. It may not be possible to connect the tubing, or leakage or disconnection may occur after connection.

Polyolefin tubing is recommended for use with clean room fittings. Note that while other types of tubing will satisfy performance standards for leakage and tubing pull-out strength, etc., the degree of cleanliness will deteriorate.



Safety Instructions

These safety instructions are intended to prevent a hazardous situation and/or equipment damage. These instructions indicate the level of potential hazard by labels of "Caution", "Warning" or "Danger". To ensure safety, be sure to observe ISO 4414 ^{Note 1)}, JIS B 8370 ^{Note 2)} and other safety practices.

 **Caution** : Operator error could result in injury or equipment damage.

 **Warning** : Operator error could result in serious injury or loss of life.

 **Danger** : In extreme conditions, there is a possible result of serious injury or loss of life.

Note 1) ISO 4414: Pneumatic fluid power--General rules relating to systems.

Note 2) JIS B 8370: General Rules for Pneumatic Equipment

Warning

1. The compatibility of pneumatic equipment is the responsibility of the person who designs the pneumatic system or decides its specifications.

Since the products specified here are used in various operating conditions, their compatibility for the specific pneumatic system must be based on specifications or after analysis and/or tests to meet your specific requirements. The expected performance and safety assurance will be the responsibility of the person who has determined the compatibility of the system. This person should continuously review the suitability of all items specified, referring to the latest catalog information with a view to giving due consideration to any possibility of equipment failure when configuring a system.

2. Only trained personnel should operate pneumatically operated machinery and equipment.

Compressed air can be dangerous if an operator is unfamiliar with it. Assembly, handling or repair of pneumatic systems should be performed by trained and experienced operators.

3. Do not service machinery/equipment or attempt to remove components until safety is confirmed.

1. Inspection and maintenance of machinery/equipment should only be performed once measures to prevent falling or runaway of the driver objects have been confirmed.
2. When equipment is to be removed, confirm the safety process as mentioned above. Cut the supply pressure for this equipment and exhaust all residual compressed air in the system.
3. Before machinery/equipment is restarted, take measures to prevent shooting-out of cylinder piston rod, etc.

4. Contact SMC if the product is to be used in any of the following conditions:

1. Conditions and environments beyond the given specifications, or if product is used outdoors.
2. Installation on equipment in conjunction with atomic energy, railway, air navigation, vehicles, medical equipment, food and beverages, recreation equipment, emergency stop circuits, clutch and brake circuits in press applications, or safety equipment.
3. An application which has the possibility of having negative effects on people, property, or animals, requiring special safety analysis.



Common Precautions

Be sure to read before handling.

For detailed precautions on every series, refer to main text.

Selection

Warning

1. Confirm the specifications.

Products represented in this catalog are designed for use in compressed air applications only (including vacuum), unless otherwise indicated.

Do not use the product outside their design parameters.

Please contact SMC when using the products in applications other than compressed air (including vacuum).

Mounting

Warning

1. Instruction manual

Install the products and operate them only after reading the instruction manual carefully and understanding its contents. Also keep the manual where it can be referred to as necessary.

2. Securing the space for maintenance

When installing the products, please allow access for maintenance.

3. Tightening torque

When installing the products, please follow the listed torque specifications.

Piping

Caution

1. Before piping

Make sure that all debris, cutting oil, dust, etc. are removed from the piping.

2. Wrapping of pipe tape

When screwing piping or fittings into ports, ensure that chips from the pipe threads or sealing material do not get inside the piping. Also, when the pipe tape is used, leave 1.5 to 2 thread ridges exposed at the end of the threads.

Air Supply

Warning

1. Operating fluid

Please consult with SMC when using the product in applications other than compressed air (including vacuum).

Regarding products for general fluid, please ask SMC about applicable fluids.

2. Install an air dryer, aftercooler, etc.

Excessive condensate in a compressed air system may cause valves and other pneumatic equipment to malfunction.

Installation of an air dryer, after cooler etc. is recommended.

3. Drain flushing

If condensate in the drain bowl is not emptied on a regular basis, the bowl will over flow and allow the condensate to enter the compressed air lines.

If the drain bowl is difficult to check and remove, it is recommended that a drain bowl with the auto-drain option be installed.

For compressed air quality, refer to "Air Preparation Equipment" catalog.

4. Use clean air

If the compressed air supply is contaminated with chemicals, synthetic materials, corrosive gas, etc., it may lead to break down or malfunction.

Operating Environment

Warning

1. Do not use in environments where the product is directly exposed to corrosive gases, chemicals, salt water, water or steam.

2. Do not expose the product to direct sunlight for an extended period of time.

3. Do not use in a place subject to heavy vibrations and/or shocks.

4. Do not mount the product in locations where it is exposed to radiant heat.

Maintenance

Warning

1. Maintenance procedures are outlined in the operation manual.

Not following proper procedures could cause the product to malfunction and could lead to damage to the equipment or machine.

2. Maintenance work

If handled improperly, compressed air can be dangerous.

Assembly, handling and repair of pneumatic systems should be performed by qualified personnel only.

3. Drain flushing

Remove drainage from air filters regularly. (Refer to the specifications.)

4. Shut-down before maintenance

Before attempting any kind of maintenance make sure the supply pressure is shut of and all residual air pressure is released from the system to be worked on.

5. Start-up after maintenance and inspection

Apply operating pressure and power to the equipment and check for proper operation and possible air leaks. If operation is abnormal, please verify product set-up parameters.

6. Do not make any modifications to be product.

Do not take the product apart.

Quality Assurance Information (ISO 9001, ISO 14001)

Reliable quality of products in the global market

To enable our customers throughout the world to use our products with even greater confidence, SMC has obtained certification for international standards “ISO 9001” and “ISO 14001”, and created a complete structure for quality assurance and environmental controls. SMC products pursue to meet its customers’ expectations while also considering company’s contribution in society.

Quality management system ISO 9001

This is an international standard for quality control and quality assurance. SMC has obtained a large number of certifications in Japan and overseas, providing assurance to our customers throughout the world.



Environmental management system ISO 14001

This is an international standard related to environmental management systems and environmental inspections. While promoting environmentally friendly automation technology, SMC is also making diligent efforts to preserve the environment.



SMC’s quality control system



Quality policies

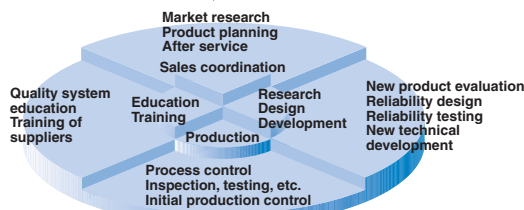

Quality control activities

SMC Product Conforming to Inter

SMC products complying with EN/ISO, CSA/UL standards are supporting



The CE mark indicates that machines and components meet essential requirements of all the EC Directives applied.

It has been obligatory to apply CE marks indicating conformity with EC Directives when machines and components are exported to the member Nations of the EU.

Once "A manufacturer himself" declares a product to be safe by means of CE marking (declaration of conformity by manufacturer), free distribution inside the member Nations of the EU is permissible.

■ CE Mark

SMC provides CE marking to products to which EMC and Low Voltage Directives have been applied, in accordance with CETOP (European hydraulics and pneumatics committee) guide lines.

■ As of February 1998, the following 18 countries will be obliged to conform to CE mark legislation

Iceland, Ireland, United Kingdom, Italy, Austria, Netherlands, Greece, Liechtenstein, Sweden, Spain, Denmark, Germany, Norway, Finland, France, Belgium, Portugal, Luxembourg

■ EC Directives and Pneumatic Components

• Machinery Directive

The Machinery Directive contains essential health and safety requirements for machinery, as applied to industrial machines e.g. machine tools, injection molding machines and automatic machines. Pneumatic equipment is not specified in Machinery Directive. However, the use of SMC products that are certified as conforming to EN Standards, allows customers to simplify preparation work of the Technical Construction File required for a Declaration of Conformity.

• Electromagnetic Compatibility (EMC) Directive

The EMC Directive specifies electromagnetic compatibility. Equipment which may generate electromagnetic interference or whose function may be compromised by electromagnetic interference is required to be immune to electromagnetic affects (EMS/immunity) without emitting excessive electromagnetic affects (EMI/emission).

• Low Voltage Directive

This directive is applied to products, which operate above 50 VAC to 1000 VAC and 75 VDC to 1500 VDC operating voltage, and require electrical safety measures to be introduced.

• Simple Pressure Vessels Directive

This directive is applied to welded vessels whose maximum operating pressure (PS) and volume of vessel (V) exceed 50 bar/L. Such vessels require EC type examination and then CE marking.

national Standards

you to comply with EC directives and CSA/UL standards.



■ CSA Standards & UL Standards

UL and CSA standards have been applied in North America (U.S.A. and Canada) symbolizing safety of electric products, and are defined to mainly prevent danger from electric shock or fire, resulting from trouble with electric products. Both UL and CSA standards are acknowledged in North America as the first class certifying body. They have a long experience and ability for issuing product safety certificate. Products approved by CSA or UL standards are accepted in most states and governments beyond question.

Since CSA is a test certifying body as the National Recognized Testing Laboratory (NRTL) within the jurisdiction of Occupational Safety and Health Administration (OSHA), SMC was tested for compliance with CSA Standards and UL Standards at the same time and was approved for compliance with the two Standards. The above CSA NRTL/C logo is described on a product label in order to indicate that the product is approved by CSA and UL Standards.

■ TSSA (MCCR) Registration Products

TSSA is the regulation in Ontario State, Canada. The products that the operating pressure is more than 5 psi (0.03 MPa) and the piping size is bigger than 1 inch. fall into the scope of TSSA regulation.

Products conforming to CE Standard



With CE symbol for simple visual recognition

In this catalog each accredited product series is indicated with a CE mark symbol. However, in some cases, every available models may not meet CE compliance. Please visit our web site for the latest selection of available models with CE mark.

<http://www.smcworld.com>

SMC's Global Service Network

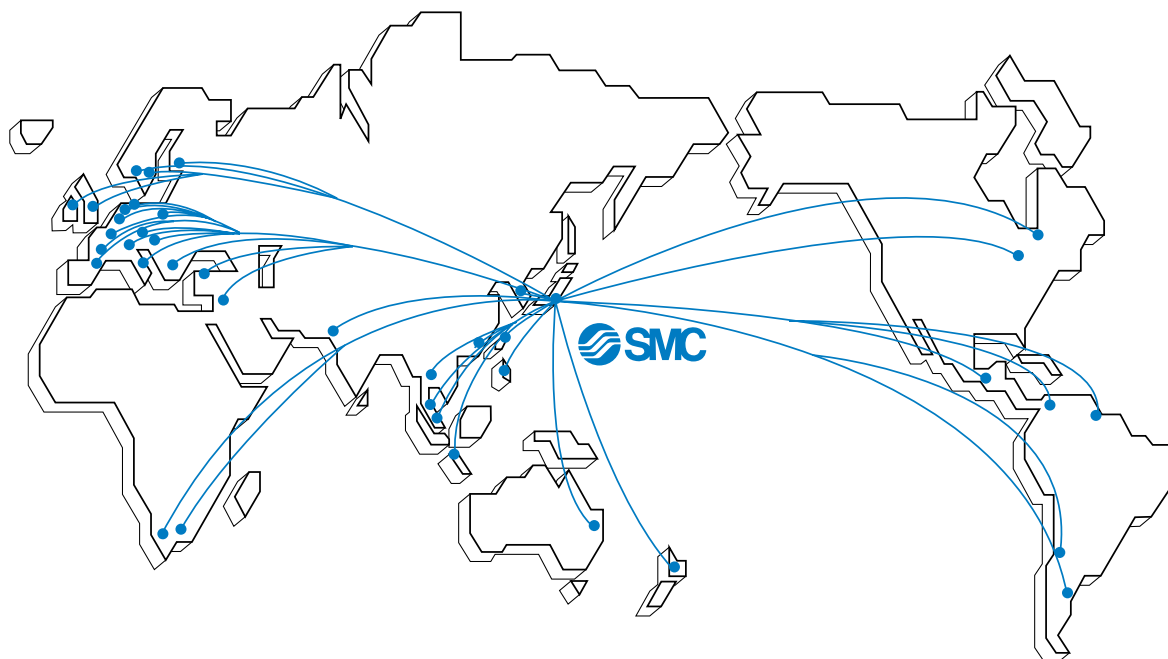

America

U.S.A. **SMC Corporation of America**

3011 North Franklin Road Indianapolis, IN 46226, U.S.A.
TEL: 317-899-4440 FAX: 317-899-3102

CANADA **SMC Pneumatics (Canada) Ltd.**

6768 Financial Drive Mississauga, Ontario, L5N 7J6 Canada
TEL: 905-812-0400 FAX: 905-812-8686

MEXICO **SMC Corporation (Mexico), S.A. DE C.V.**

Carr. Silao-Trejo K.M. 2.5 S/N, Predio San Jose del Duranzo
C.P. 36100, Silao, Gto., Mexico
TEL: 472-72-2-55-00 FAX: 472-72-2-59-44/2-59-46

CHILE **SMC Pneumatics (Chile) S.A.**

Av. La Montaña 1,115 km. 16,5 P. Norte Parque
Industrial Valle Grande, Lampa Santiago, Chile
TEL: 02-270-8600 FAX: 02-270-8601

ARGENTINA **SMC Argentina S.A.**

Teodoro Garcia 3860 (1427) Buenos Aires, Argentina
TEL: 011-4555-5762 FAX: 011-4555-5762

BOLIVIA **SMC Pneumatics Bolivia S.R.L.**

Avenida Beni Numero 4665
Santa Cruz de la Sierra-Casilla de Correo 2281, Bolivia
TEL: 591-3-3428383 FAX: 591-3-3449900

VENEZUELA **SMC Neumatica Venezuela S.A.**

Apartado 40152, Avenida Nueva Granada, Edificio Wanlac,
Local 5, Caracas 1040-A, Venezuela
TEL: 2-632-1310 FAX: 2-632-3871

PERU (Distributor) **IMPECO Automatizacion Industrial S.A.**

AV. Canevaro 752, Lince, Lima, Peru
TEL: 1-471-6002 FAX: 1-471-0935

URUGUAY (Distributor) **BAKO S.A.**

Galicia 1650 esq. Gaboto C.P. 11200, Montevideo, Uruguay
TEL: 2-401-6603 FAX: 2-409-4306

BRAZIL **SMC Pneumaticos Do Brasil Ltda.**

Rua. Dra. Maria Fidelis, nr. 130, Jardim Piraporinha-Diadema-S.P.
CEP: 09950-350, Brasil
TEL: 11-4051-1177 FAX: 11-4071-6636

COLOMBIA (Distributor) **Airmatic Ltda.**

Calle 18 69-05 Apart. Aereo 081045 Santa Fe de Bogotá, Colombia
TEL: 1-424-9240 FAX: 1-424-9260

Europe

U.K. **SMC Pneumatics (U.K.) Ltd.**

Vincent Avenue, Crownhill, Milton Keynes, MK8 0AN, Buckinghamshire, U.K.
TEL: 01908-563888 FAX: 01908-561185

GERMANY **SMC Pneumatik GmbH**

Boschring 13-15 D-63329 Egelsbach, Germany
TEL: 06103-4020 FAX: 06103-402139

ITALY **SMC Italia S.p.A.**

Via Garibaldi 62 I-20061 Carugate Milano, Italy
TEL: 02-9271365 FAX: 02-9271365

FRANCE **SMC Pneumatique S.A.**

1 Boulevard de Strasbourg, Parc Gustave Eiffel, Bussy Saint Georges, F-77600
Marne La Vallee Cedex 3 France
TEL: 01-64-76-10-00 FAX: 01-64-76-10-10

SWEDEN **SMC Pneumatics Sweden AB**

Ekhagsvägen 29-31, S-141 05 Huddinge, Sweden
TEL: 08-603-07-00 FAX: 08-603-07-10

SWITZERLAND **SMC Pneumatik AG**

Dorfstrasse 7, Postfach 117, CH-8484 Weisslingen, Switzerland
TEL: 052-396-3131 FAX: 052-396-3191

AUSTRIA **SMC Pneumatik GmbH (Austria)**

Girakstrasse 8, A-2100 Korneuburg, Austria
TEL: 0-2262-6228-0 FAX: 0-2262-62285

SPAIN **SMC España, S.A.**

Zuazobidea 14 Pol. Ind. Júndiz 01015 Vitoria, Spain
TEL: 945-184-100 FAX: 945-184-510

IRELAND **SMC Pneumatics (Ireland) Ltd.**

2002 Citywest Business Campus, Naas Road, Saggart, Co. Dublin, Ireland
TEL: 01-403-9000 FAX: 01-466-0385

NETHERLANDS (Associated company) **SMC Pneumatics BV**

De Ruyterkade 120, NL-1011 AB Amsterdam, Netherlands
TEL: 020-5318888 FAX: 020-5318880

GREECE (Distributor) **S.Parianopoulos S.A.**

7, Konstantinoupoleos Street 11855 Athens, Greece
TEL: 01-3426076 FAX: 01-3455578

DENMARK **SMC Pneumatik A/S**

Knudsminde 4 B DK-8300
Odder, Denmark
TEL: 70252900 FAX: 70252901

Europe

FINLAND **SMC Pneumatics Finland OY**

PL72, Tiistinniityntie 4, SF-02231 ESP00, Finland
TEL: 09-8595-80 FAX: 09-8595-8595

NORWAY **SMC Pneumatics Norway A/S**

Vollsveien 13C, Granfoss Næringspark N-1366 LYSAKER, Norway
TEL: 67-12-90-20 FAX: 67-12-90-21

BELGIUM (Distributor) **SMC Pneumatics N.V./S.A.**

Nijverheidsstraat 20 B-2160 Wommelgem Belgium
TEL: 03-355-1464 FAX: 03-355-1466

POLAND **SMC Industrial Automation Polska Sp.z.o.o.**

ul. Konstruktorska 11A, PL-02-673 Warszawa, Poland
TEL: 022-548-5085 FAX: 022-548-5087

TURKEY (Distributor) **Entek Pnömatik San.ve Tic. Ltd. Sti**

Perpa Tic. Merkezi Kat:11 No.1625 80270 Okmeydani Istanbul, Türkiye
TEL: 0212-221-1512 FAX: 0212-221-1519

RUSSIA **SMC Pneumatik LLC.**

36/40 Sredny prospect V.O. St. Petersburg 199004, Russia
TEL: 812-118-5445 FAX: 812-118-5449

CZECH **SMC Industrial Automation CZ s.r.o.**

Hudcova 78a, CZ-61200 Brno, Czech Republic
TEL: 05-4121-8034 FAX: 05-4121-8034

HUNGARY **SMC Hungary Ipari Automatizálási kft.**

Budafoki ut 107-113 1117 Budapest
TEL: 01-371-1343 FAX: 01-371-1344

ROMANIA **SMC Romania S.r.l.**

Str. Frunzei, Nr. 29, Sector 2, Bucharest, Romania
TEL: 01-3205111 FAX: 01-3261489

SLOVAKIA **SMC Priemyselná automatizácia, s.r.o.**

Nova 3, SK-83103 Bratislava
TEL: 02-4445-6725 FAX: 02-4445-6028

SLOVENIA **SMC Industrijska Avtomatila d.o.o.**

Grajski trg 15, SLO- 8360 Zuzemberk, Slovenia
TEL: 07388-5240 FAX: 07388-5249

LATVIA **SMC Pneumatics Latvia SIA**

Šmerļa ielā 1-705, Rīga LV-1006
TEL: 777 94 74 FAX: 777 94 75

SOUTH AFRICA (Distributor) **Hyflo Southern Africa (Pty.) Ltd.**

P.O.Box 240 Paardeneiland 7420 South Africa
TEL: 021-511-7021 FAX: 021-511-4456

EGYPT (Distributor) **Saadani Trading & Ind. Services**

15 Sebaai Street, Miami 21411 Alexandria, Egypt
TEL: 3-548-50-34 FAX: 3-548-50-34

Oceania/Asia

AUSTRALIA **SMC Pneumatics (Australia) Pty.Ltd.**

14-18 Hudson Avenue Castle Hill NSW 2154, Australia
TEL: 02-9354-8222 FAX: 02-9894-5719

NEW ZEALAND **SMC Pneumatics (New Zealand) Ltd.**

8C Sylvia Park Road Mt.Wellington Auckland, New Zealand
TEL: 09-573-7007 FAX: 09-573-7002

TAIWAN **SMC Pneumatics (Taiwan) Co.,Ltd.**

17, Lane 205, Nansan Rd., Sec.2, Luzhu-Hsiang, Taoyuan-Hsien, TAIWAN
TEL: 03-322-3443 FAX: 03-322-3387

HONG KONG **SMC Pneumatics (Hong Kong) Ltd.**

29/F, Clifford Centre, 778-784 Cheung, Sha Wan Road, Lai Chi Kok, Kowloon, Hong Kong
TEL: 2744-0121 FAX: 2785-1314

SINGAPORE **SMC Pneumatics (S.E.A.) Pte. Ltd.**

89 Tuas Avenue 1, Jurong Singapore 639520
TEL: 6861-0888 FAX: 6861-1889

PHILIPPINES **SHOKETSU SMC Corporation**

Unit 201 Common Goal Tower, Madrigal Business Park, Ayala Alabang Muntinlupa, Philippines
TEL: 02-8090565 FAX: 02-8090586

MALAYSIA **SMC Pneumatics (S.E.A.) Sdn. Bhd.**

Lot 36 Jalan Delima1/1, Subang Hi-Tech Industrial Park, Batu 3 40000 Shah Alam Selangor, Malaysia
TEL: 03-56350590 FAX: 03-56350602

SOUTH KOREA **SMC Pneumatics Korea Co., Ltd.**

Woolim e-BIZ Center (Room 1008), 170-5, Guro-Dong, Guro-Gu, Seoul, 152-050, South Korea
TEL: 02-3219-0700 FAX: 02-3219-0702

CHINA **SMC (China) Co., Ltd.**

7 Wan Yuan St. Beijing Economic & Technological Development Zone 100176, China
TEL: 010-67882111 FAX: 010-67881837

THAILAND **SMC Thailand Ltd.**

134/6 Moo 5, Tiwanon Road, Bangkadi, Amphur Muang, Patumthani 12000, Thailand
TEL: 02-963-7099 FAX: 02-501-2937

INDIA **SMC Pneumatics (India) Pvt. Ltd.**

D-107 to 112, Phase-2, Extension, Noida, Dist. Gautaim Budh Nagar, U.P. 201 305, India
TEL: (0120)-4568730 FAX: 0120-4568933

INDONESIA (Distributor) **P.T. Riyadi Putera Makmur**

Jalan Hayam Wuruk Komplek Glodok Jaya No. 27-28 Jakarta 11180 Indonesia
TEL: 021-625 5548 FAX: 021-625 5888

PAKISTAN (Distributor) **Jubilee Corporation**

First Floor Mercantile Centre, Newton Road Near Boulton Market P.O. Box 6165 Karachi 74000 Pakistan
TEL: 021-243-9070/8449 FAX: 021-241-4589

ISRAEL (Distributor) **Baccara Automation Control**

Kvutza Geva 18915 Israel
TEL: 04-653-5960 FAX: 04-653-1445

SAUDI ARABIA (Distributor) **Assaggaff Trading Est.**

P.O. Box 3385 Al-Amir Majed Street, Jeddah-21471, Saudi Arabia
TEL: 02-6761574 FAX: 02-6708173