



# Precision Clean Regulator *Series SRP*



High precision, low flow consumption stainless steel regulator

# Precision Clean Regulator *Series SRP*

**High precision, low flow consumption stainless steel regulator**



**Achieves flow consumption "under a liter"**

**Bleed volume 0.5 /min(ANR) or less (downstream pressure at 0.2MPa)**

\* Approx. 1/4 of the ARP3000 direct operated precision regulator

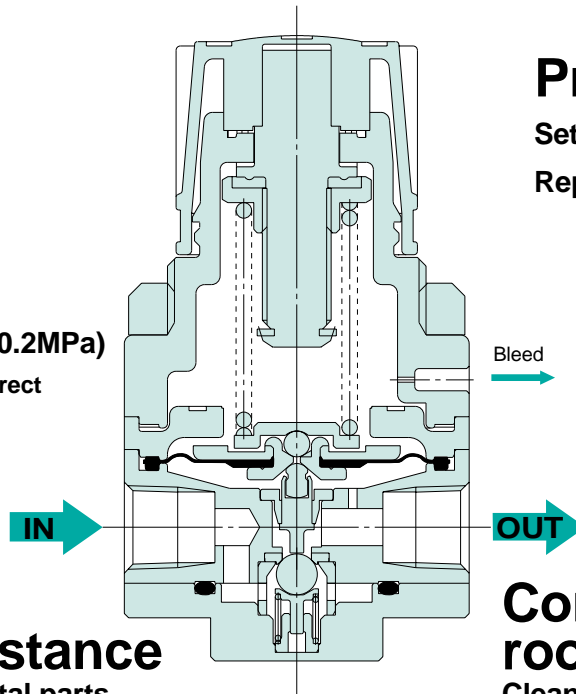

**Precision**

Setting sensitivity: 0.3%F.S.

Repeatability: 1%F.S.

**Oil free**

Parts composition with no use of oils.

HFC1416 ultrasonic cleaning of all fluid-contact parts.

**Excellent corrosion resistance**

SUS316 is used for all metal parts in contact with the fluid.

**Consistent clean room production**

Cleaned, assembled, inspected, and sealed in double packaging in a Class 10,000 environment

## Applications

### Pressure feed of chemicals

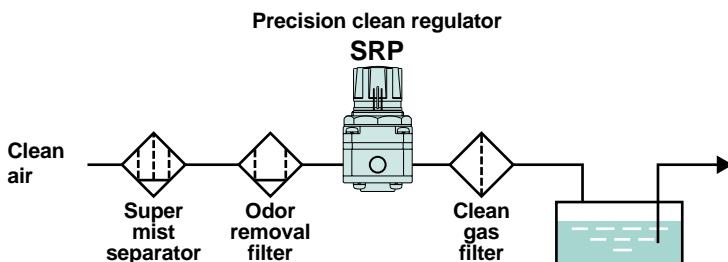

### N2 blow

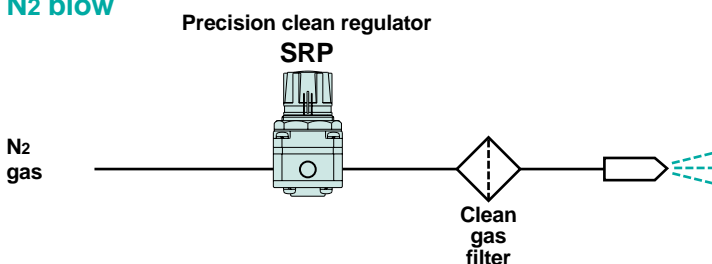

## Manufacturing process

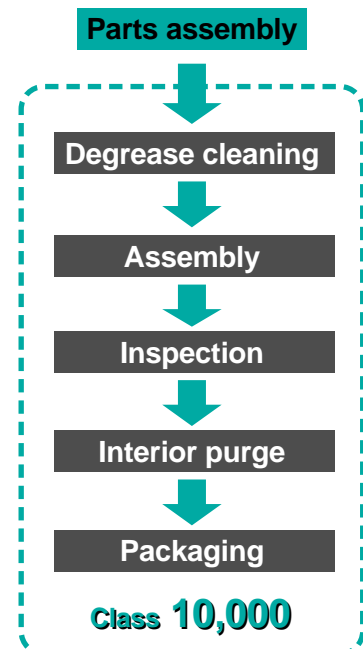

# Precision Clean Regulator

## Series **SRP**

### How to Order



JIS symbol

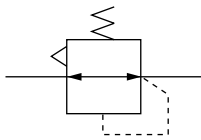

SRP 1 1 0 1 — 01 — R

Set pressure

0	0.005 to 0.2MPa
1	0.01 to 0.4MPa

Port size

Symbol	Piping port size
M5	M5 x 0.8
01	Rc 1/8

Gauge port orientation

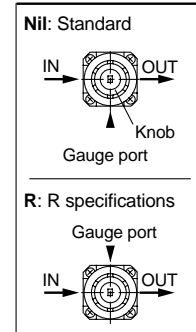

\* Gauge port positions are indicated with the knob on the top side.

### Options

Description	Model	Material
Bracket	<b>B21-1-T1</b>	Rolled steel plate (electroless nickel plated)

### Specifications

Connection port size		M5, Rc 1/8
Fluid		Air, N <sub>2</sub> , CO <sub>2</sub> , Ar
Proof pressure MPa		1.5
Maximum operating pressure MPa		1.0
Regulating pressure range MPa	Low pressure type	0.005 to 0.2
	High pressure type	0.01 to 0.4
Ambient and fluid temperature (°C)		0 to 60
Fluid consumption /min (ANR) <small>Note 1)</small>		0.5 or less
Sensitivity		0.3% of full span
Repeatability		±1% of full span
Fluid-contact parts	Metal	SUS316
	Resin	Fluororesin
	Rubber	Fluoro rubber
	Other	Ceramics
Assembly environment		Clean room class 10000
Parts cleaning		HCFC141b ultrasonic cleaning of all fluid-contact parts

Note 1) At set pressure of 0.2MPa

# Series SRP

## Flow Characteristics

Fluid: Air

SRP1101-M5

Conditions/Upstream pressure: 0.5MPa

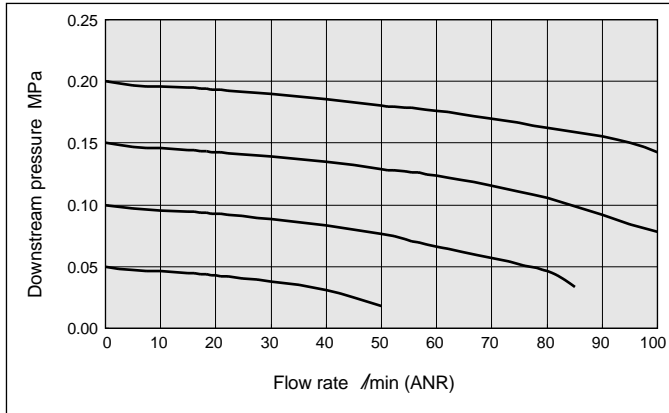

SRP1111-M5

Conditions/Upstream pressure: 0.7MPa

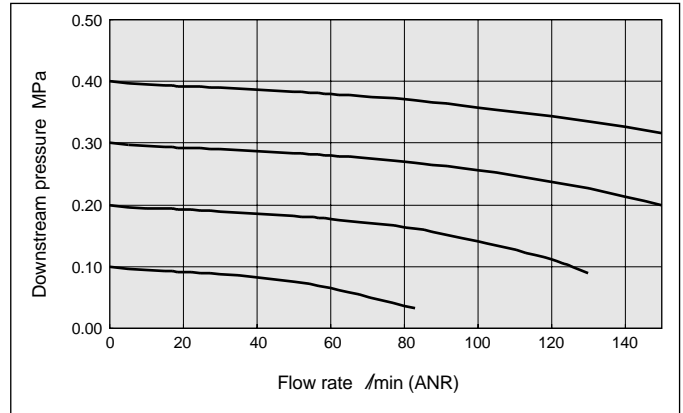

SRP1101-01

Conditions/Upstream pressure: 0.5MPa

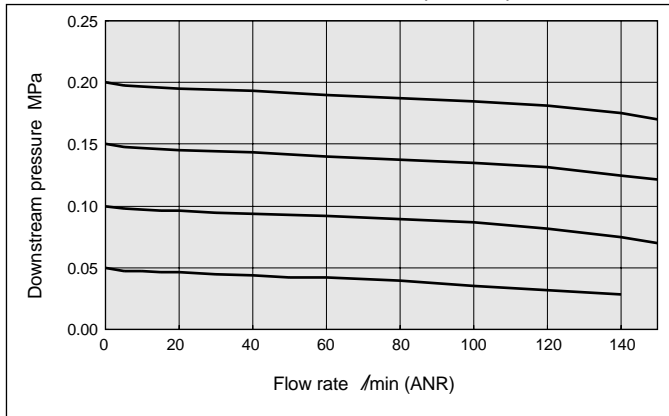

SRP1111-01

Conditions/Upstream pressure: 0.7MPa

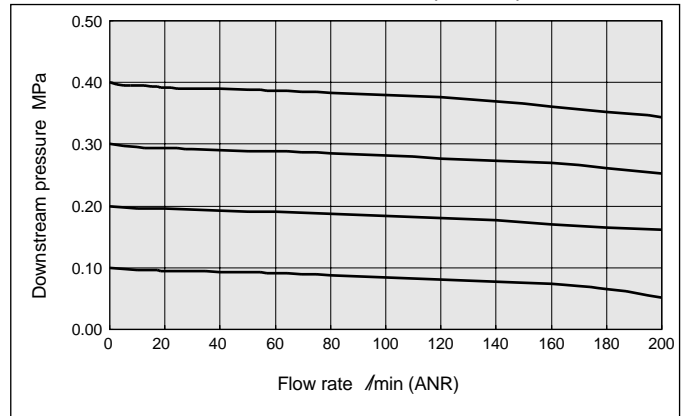

## Pressure Characteristics

Fluid: Air

SRP1101

Initial setting/Upstream pressure: 0.7MPa  
Downstream pressure: 0.1MPa

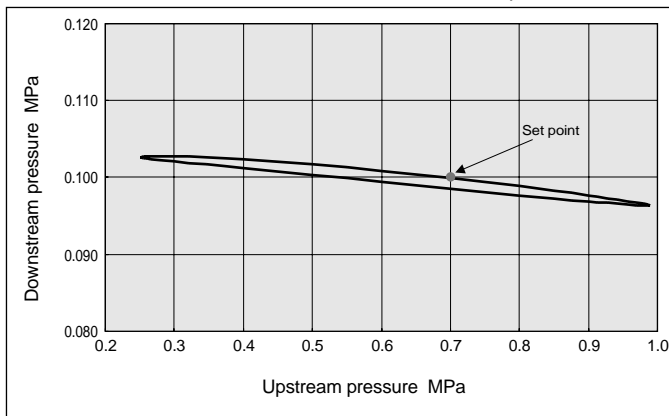

SRP1111

Initial setting/Upstream pressure: 0.7MPa  
Downstream pressure: 0.2MPa

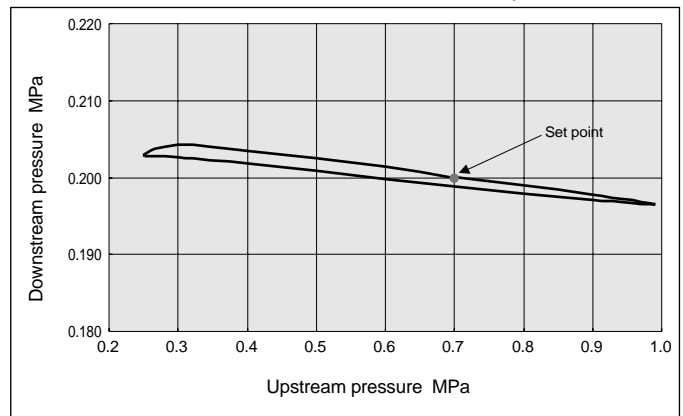

## Construction

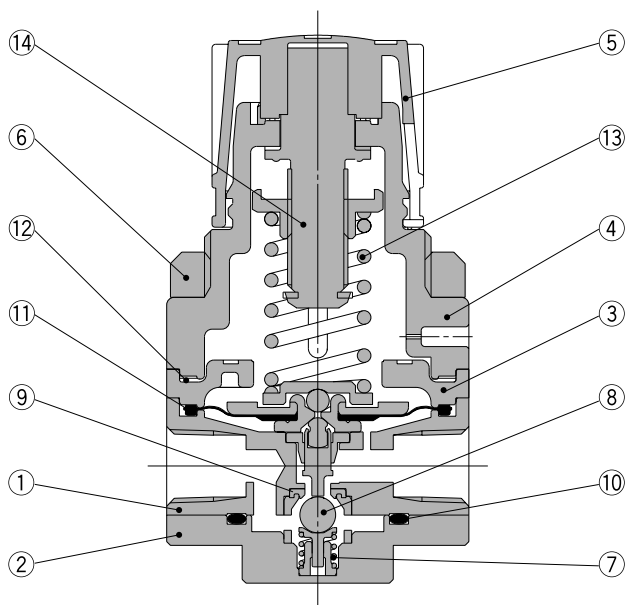

### Parts list

No.	Description	Material	Treatment
1	Body	SUS316L	
2	Valve guide	SUS316	
3	Spacer	PPS	
4	Bonnet	PPS	
5	Knob	PBT	
6	Set nut	ZDC	Electroless nickel plated
7	Valve spring	SUS316	
8	Main valve	Ceramics	
9	Valve seat	PTFE	
10	O-ring	Fluoro rubber	
11	Diaphragm	Fluoro rubber	
12	Gasket	Fluoro rubber	
13	Pressure regulator spring	Steel wire	
14	Pressure regulator screw assembly	—	

## Dimensions

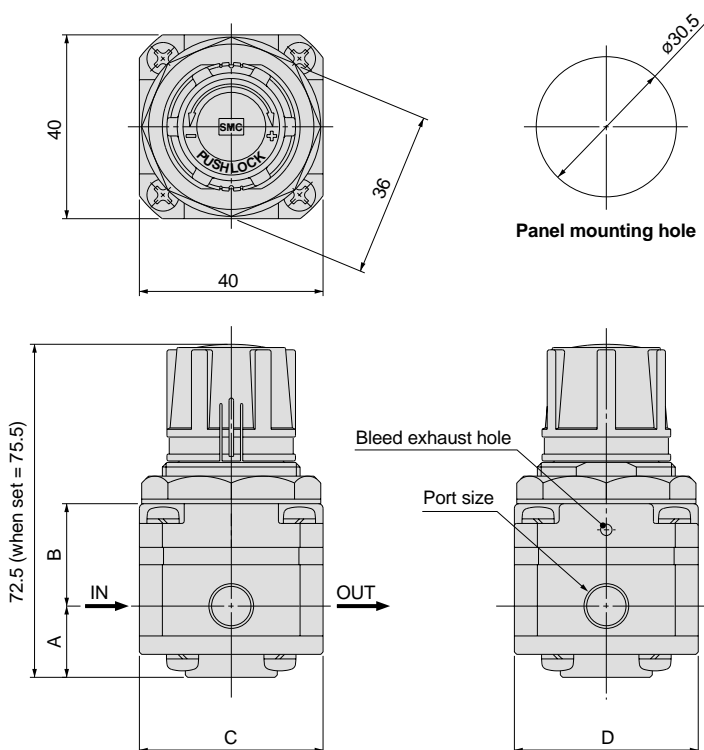

### Bracket

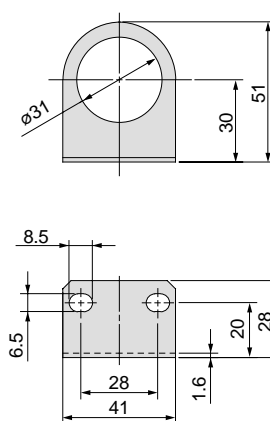



Model	Port size	A	B	C	D
SRP11□1-M5	M5 x 0.8	14	23.5	30	30
SRP11□1-01	Rc 1/8	15	22.5	40	40



# Series *SRP* Safety Instructions

These safety instructions are intended to prevent a hazardous situation and/or equipment damage. These instructions indicate the level of potential hazard by a label of "**Caution**", "**Warning**" or "**Danger**". To ensure safety, be sure to observe ISO 4414 Note 1), JIS B 8370 Note 2) and other safety practices.

 **Caution** : Operator error could result in injury or equipment damage.

 **Warning** : Operator error could result in serious injury or loss of life.

 **Danger** : In extreme conditions, there is a possible result of serious injury or loss of life.

Note 1) ISO 4414: Pneumatic fluid power – Recommendations for the application of equipment to transmission and control systems

Note 2) JIS B 8370: General Rules for Pneumatic Equipment

## **Warning**

### **1. The compatibility of equipment is the responsibility of the person who designs the system or decides its specifications.**

Since the products specified here are used in various operating conditions, their compatibility for the specific system must be based on specifications or after analysis and/or tests to meet your specific requirements.

### **2. Only trained personnel should operate machinery and equipment.**

The fluid can be dangerous if handled incorrectly. Assembly, handling or repair of systems should be performed by trained and experienced operators.

### **3. Do not service machinery/equipment or attempt to remove components until safety is confirmed.**

1. Inspection and maintenance of machinery/equipment should only be performed after confirmation of safe locked-out control positions.
2. When equipment is to be removed, confirm the safety process as mentioned above. Cut the fluid and power supplies for this equipment and release all residual pressure in the system.
3. Before machinery/equipment is restarted, take measures to prevent shooting-out of cylinder piston rod, etc., and proceed with caution.

### **4. Contact SMC if the product is to be used in any of the following conditions:**

1. Conditions and environments beyond the given specifications, or if product is used outdoors.
2. Installation on equipment in conjunction with atomic energy, railway, air navigation, vehicles, medical equipment, food and beverages, recreation equipment, emergency stop circuits, press applications, or safety equipment.
3. An application which has the possibility of having negative effects on people, property, or animals, requiring special safety analysis.



# Series SRP/Specific Product Precautions

Be sure to read before handling.

Refer to page 4 for Safety instructions.

## Design and Selection

### ⚠ Warning

#### 1. Types of fluid

This product is designed for use with air, N<sub>2</sub>, CO<sub>2</sub> and Ar as fluids. Consult SMC if it will be used with any other fluids.

Since this product uses a bleed mechanism and fluid is released from the bleed hole, poisonous or corrosive gases cannot be used.

#### 2. Fluids containing solids cannot be used.

Since this can cause malfunction, install a mist separator, etc., upstream from the regulator.

#### 3. For air containing a large amount of drainage, install an air dryer or after cooler, etc., upstream from the regulator.

This can otherwise cause malfunction.

#### 4. Do not use in locations subject to vibration or impact.

#### 5. Avoid direct sunlight by providing a protective cover, etc.

#### 6. When sources of heat are located nearby, block off any radiated heat.

### ⚠ Caution

#### 1. It is recommended that the downstream pressure be set in the range of 25 to 85% of the upstream pressure.

## Mounting

### ⚠ Caution

#### 1. Open the sealed package inside a clean room.

This product is packaged in sealed double packaging in a clean room. It is recommended that the inside packaging be opened in a clean room or other clean environment.

#### 2. Flush out the piping.

Connect this product to piping only after the piping has been flushed or washed, etc. If debris or scale, etc., remains in the piping, this can cause malfunction or failure.

#### 3. Keep sealing material from getting inside the piping.

When screwing in pipes and fittings, etc., take care that chips from the pipe threads, sealing material, and other debris do not get inside the piping. If debris or scale, etc., remain inside the piping, this can cause malfunction or failure. Also, when pipe tape is used, leave 1.5 to 2 threads ridges exposed at the end of the threads.

#### 4. Confirm the mounting orientation of the product.

The side marked IN is the fluid inlet, and the side marked OUT is the fluid outlet. If mounted backwards, the product will not operate properly.

#### 5. Do not block the bleed hole.

If the bleed hole is blocked, the product will not operate properly.

## Pressure Adjustment

### ⚠ Warning

#### 1. Do not use tools when operating the pressure regulator knob.

If tools, etc., are used to operate the pressure regulator knob, damage can occur. Operate this knob only by hand.

#### 2. Perform settings while confirming upstream and downstream pressure indicators.

Turning the knob more than necessary can cause damage to internal parts.

### ⚠ Caution

#### 1. Perform pressure adjustments only after releasing the lock.

When the pressure regulator knob will not turn, it is locked. Release the lock by pulling the pressure regulator knob out. If the knob is turned by force damage will occur.

After adjusting the pressure, lock the knob again by pressing it back down.

#### 2. Adjust pressure in an upward direction.

A correct pressure setting cannot be achieved by adjusting the pressure downward. The downstream pressure is increased by turning the pressure regulator knob to the right, and decreased by turning the knob to the left.

#### 3. Confirm the upstream pressure.

Set the downstream pressure to no more than 85% of the upstream pressure. If the upstream pressure is too low, a correct set pressure cannot be attained.

#### 4. A small volume of fluid will be expended from the bleed hole.

The bleed mechanism is used to perform high precision pressure adjustment. Therefore, it is not abnormal for a small volume of fluid to be expended from the bleed hole.



## SMC'S GLOBAL MANUFACTURING, DISTRIBUTION AND SERVICE NETWORK

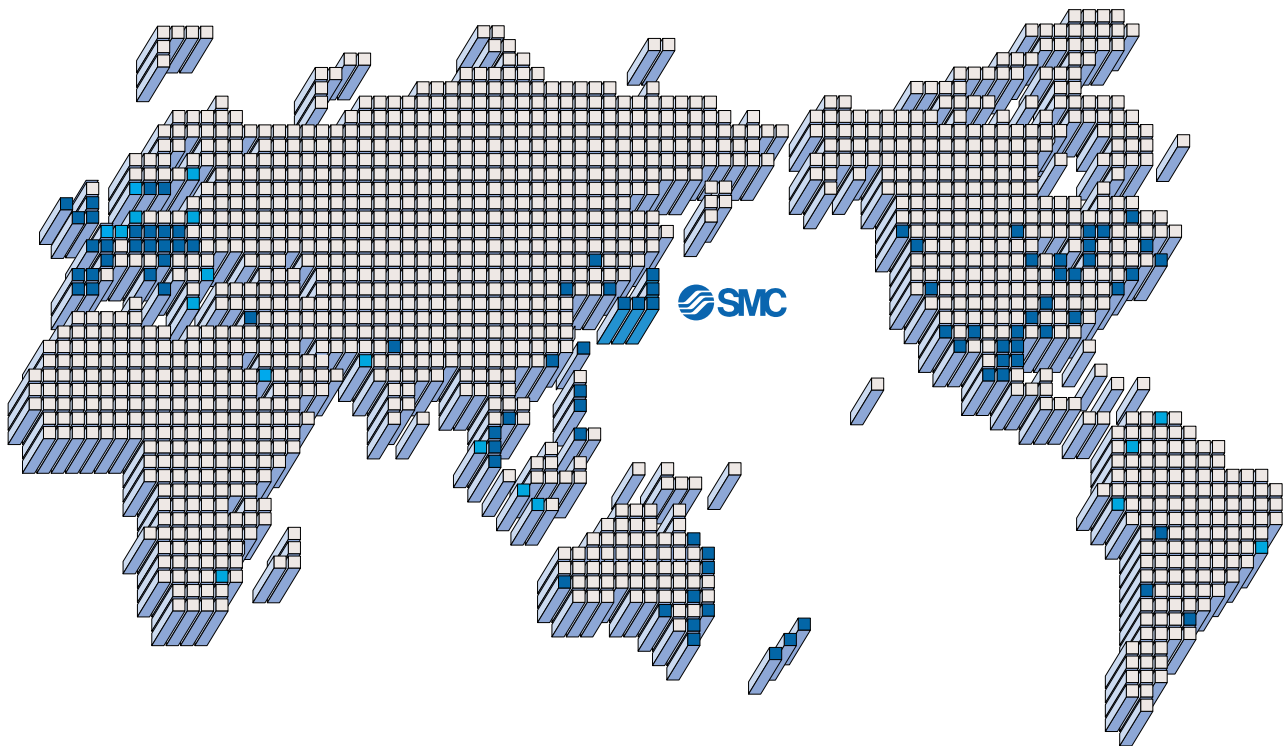

### EUROPE

**AUSTRIA**  
SMC Pneumatik GmbH

**CZECH**  
SMC Czech s.r.o.

**DENMARK**  
SMC Pneumatik A/S

**FINLAND**  
SMC Pneumatiikka OY

**FRANCE**  
SMC Pneumatique SA

**GERMANY**  
SMC Pneumatik GmbH

**HUNGARY**  
SMC Hungary Kft.

**IRELAND**  
SMC Pneumatics (Ireland) Ltd.

**ITALY**  
SMC Italia S.p.A.

**NETHERLANDS**  
SMC Pneumatics BV.

**NORWAY**  
SMC Pneumatics Norway A/S

**ROMANIA**  
SMC Romania s.r.l.

**RUSSIA**  
SMC Pneumatik LLC.

**SLOVAKIA**  
SMC Slovakia s.r.o.

**SLOVENIA**  
SMC Slovenia d.o.o.

### EUROPE

**SPAIN/PORTUGAL**  
SMC España, S.A.

**SWEDEN**  
SMC Pneumatics Sweden AB

**SWITZERLAND**  
SMC Pneumatik AG.

**UK**  
SMC Pneumatics (U.K.) Ltd.

### ASIA

**CHINA**  
SMC (China) Co., Ltd.

**HONG KONG**  
SMC Pneumatics (Hong Kong) Ltd.

**INDIA**  
SMC Pneumatics (India) Pvt. Ltd.

**MALAYSIA**  
SMC Pneumatics (S.E.A.) Sdn. Bhd.

**PHILIPPINES**  
SMC Pneumatics (Philippines), Inc.

**SINGAPORE**  
SMC Pneumatics (S.E.A.) Pte. Ltd.

**SOUTH KOREA**  
SMC Pneumatics Korea Co., Ltd.

**TAIWAN**  
SMC Pneumatics (Taiwan) Co., Ltd.

**THAILAND**  
SMC Thailand Ltd.

### NORTH AMERICA

**CANADA**  
SMC Pneumatics (Canada) Ltd.

**MEXICO**  
SMC Corporation (Mexico) S.A. de C.V.

**USA**  
SMC Pneumatics, Inc.

### SOUTH AMERICA

**ARGENTINA**  
SMC Argentina S.A.

**BOLIVIA**  
SMC Pneumatics Bolivia S.R.L.

**BRAZIL**  
SMC Pneumaticos Do Brazil Ltda.

**CHILE**  
SMC Pneumatics (Chile) S.A.

**VENEZUELA**  
SMC Neumatica Venezuela S.A.

### OCEANIA

**AUSTRALIA**  
SMC Pneumatics (Australia) Pty. Ltd.

**NEW ZEALAND**  
SMC Pneumatics (N.Z.) Ltd.

## SMC CORPORATION

1-16-4 Shimbashi, Minato-ku, Tokyo 105-0004, JAPAN  
Tel: 03-3502-2740 Fax: 03-3508-2480  
URL <http://www.smcworld.com>  
© 1999 SMC CORPORATION All Rights Reserved