

Process Pump

Series PA3000/5000, PAX1000

Series PB1000

Compact, high capacity diaphragm pump for transfer and recovery of a wide variety of fluids

- Long service life, 2 to 5 times that of conventional pumps
Incorporates a new diaphragm material.
Enlarged bore size and shortened stroke extend life.
(Compared to series PA2000)
- High abrasion resistance and low particle generation
No sliding parts in wetted areas.
- Self-priming makes priming unnecessary

Process pump Series PA3000/5000

Automatically operated type/Air operated type
(Internal switching type) (External switching type)



Automatically operated type

Compatible with a wide variety of fluids

Air operated type

Control with external switching valve makes constant cycling possible

Built-in pulsation attenuator Process pump Series PAX1000

Automatically operated type
(Internal switching type)

Prevents spraying of discharge and foaming in tank



Compact single acting Process pump Series PB1000

Built-in solenoid valve type/Air operated type
(External switching type) (External switching type)



A solenoid valve operated pump that fits in the palm of the hand

Variations

Series PA: Double Acting Pump

Series	Model	Action	Discharge flow rate (ℓ/min)	Material	
				Body	Diaphragm
PA3000	PA3□□0	Automatically operated type	1 to 20	ADC12 (Aluminum)	PTFE
	PA5□□0		5 to 45		
PA5000	PA3□13	Air operated type	0.1 to 12	SCS14 (Stainless steel)	PTFE
	PA5□13		1 to 24		
PAX1000	PAX1□12	Automatically operated type with built-in pulsation attenuator	0.5 to 10	ADC12 (Aluminum) SCS14 (Stainless steel)	PTFE

Series PB: Single Acting Pump

PB1000	PB1011	Built-in solenoid valve	0.008 to 2	Polypropylene	PTFE
	PB1013	Air operated type	0.008 to 0.5		

Application Example

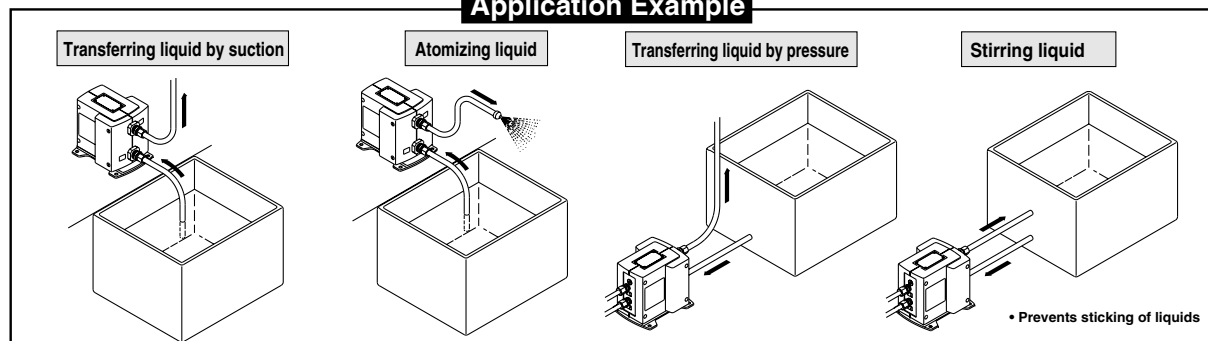

VC□

VDW

VQ

VX2

VX□

VX3

VXA

VN□

LVC

LVA

L VH

LVD

L VQ

LQ

LVN

T/
TIL

PA

PAX

PB

Precautions 1

Be sure to read before handling. Refer to pages 17-6-3 to 17-6-10 for Safety Instructions and Solenoid Valve Precautions.

Caution on Design

Warning

1. Confirm the fluid to be used.

Be sure to confirm the specifications, as the fluids to be used differ depending on the product. When different fluids are used, characteristics change and this can cause faulty operation.

2. Fluid temperature

Use each model within its respective fluid temperature range.

3. Fluid quality

If fluid is used which contains foreign matter, troubles such as malfunction and seal failure may occur due to wearing of valve seats and sticking, etc. Install a suitable filter (strainer) immediately before the pump. As a general rule, mesh of about 80 to 100 can be used.

4. Be sure to observe the maximum operating pressure.

Operation above the maximum operating pressure can cause damage. In particular, avoid application of pressure above the specifications caused by water hammer.

<Example Pressure Reduction Measures>

- a) Use a water hammer relief valve and slow the valve's closing speed.
- b) Absorb impact pressure by using elastic piping material such as rubber, or an accumulator, etc.

5. Liquid seals

In cases with a flowing liquid, provide a by-pass valve in the system to prevent the liquid from entering the liquid seal circuit.

6. Quality of operating air

- 1) Use clean air.
Do not use compressed air which contains chemicals, synthetic oils containing organic solvents, salts or corrosive gases, etc., as these can cause damage or malfunction.
- 2) Install an air filter near valves on their upstream side.
Choose a filtration degree of 5 μm or finer. A mist separator (AM) is suitable.
- 3) Compressed air which includes a large amount of drainage can cause malfunction of valves and other pneumatic equipment. As a countermeasure, install an air dryer or after cooler, etc.
- 4) In situations where a large amount of carbon dust is generated, install a mist separator at the upstream side of valves to remove it. When a lot of carbon dust is generated from a compressor, it can adhere to the interior of valves and cause malfunction.
- 5) If a pump is operated by dried air and N₂ gas, etc., the deterioration of the gaskets inside the switching valve will be accelerated and may result in substantially shortening the life span of the product.
Refer to the SMC "Air Cleaning Equipment" catalog for details on air quality.

7. Ensure space for maintenance.

Be sure to allow the space required for maintenance and inspection.

8. Fluid properties

1. Do not use strong acids, strong bases or chemicals which can affect humans.
2. When inflammable fluids are transferred, give consideration to leakage during operation, and strictly prohibit flames. There is a danger of fire or explosion due to accidental leakage of the fluid.

9. Stopping the pump

- 1) Use a 3 port solenoid valve when starting or stopping an automatically operated type pump by means of pilot air. Do not use a 2 port solenoid valve. (In the case of a 2 port solenoid valve, the air pressure which remains after the solenoid valve closes is gradually consumed inside the process pump. This causes instability in the operating position of the pilot air switching unit, and it may become inoperable. Since the same kind of problem also occurs when the air supply pressure is gradually lost after operation is stopped, a 3 port solenoid valve should be used for stopping. When the unit will not be restarted, press the reset button.)
- 2) The solenoid valve used for the air operated type should be an exhaust center 5 port solenoid valve, or a combination of a residual pressure exhaust 3 port solenoid valve and a pump drive 4 port solenoid valve. (Refer to page 17-5-156.) If air in the drive chamber is not released when the pump is stopped, the diaphragm will be subjected to pressure and its life will be shortened. Make a selection after confirming the maximum operating frequency of a solenoid valve.
- 3) The air operated type can also be used for highly permeable fluids. In this case, since the exhaust contains gas from the fluid which permeates the diaphragm, employ measures to keep the exhaust from getting into the solenoid valve.
- 4) When an air operated pump is dry, operate the solenoid valve at a switching cycle of 1 to 7 Hz. If operated outside of this range, the suction lifting height may be less than the rated value.

10. Others

- 1) Test the unit before using it in an actual equipment application. Furthermore, even if there is no problem in a short term test, there are cases in which trouble is caused by permeation through the fluororesin diaphragm to the air side.
- 2) Since the compatibility of fluids differs depending on type, additives, concentration and temperature, etc., give careful attention to the selection of materials.
- 3) When used with gases, the prescribed performance may not be achieved.
- 4) Do not operate for an extended time without liquid in the pump.

Caution

1. Use a design which prevents reverse pressure and reverse flow.

If reverse pressure or flow occurs, this can cause equipment damage or malfunction, etc. Give attention to safety measures, including the method of handling.

⚠ Precautions 2

Be sure to read before handling. Refer to pages 17-6-3 to 17-6-10 for Safety Instructions and Solenoid Valve Precautions.

Selection

⚠ Warning

1. Confirm the specifications.

Give careful consideration to operating conditions such as the application, fluid and environment, and use within the operating ranges specified in this catalog.

2. Type of fluid

Operate only after confirming the materials and applicable fluids for each model to determine which fluids can be used.

3. Equipment selection

When selecting equipment, make a selection from the latest catalog, staying within specified operating ranges, and carefully confirming the purpose of use, the required specifications and the operating conditions (pressure, flow rate, temperature, environment). In case of any unclear points, contact SMC in advance.

Mounting

⚠ Warning

1. Instruction manual

The product should be mounted after reading the manual carefully and having a good understanding of its contents. The manual should also be kept where it can be referred to whenever necessary.

2. Confirm the mounting position.

- Since the mounting position is different for each piece of equipment, this point should be confirmed either in this catalog or in the instruction manual.
- The mounting orientation is limited. (Refer to page 17-5-141.) Mount with the bottom (foot hole or mounting hole side) facing down.
- Since the reciprocal motion of the diaphragm propagates, the mounting bolts should be tightened securely. Furthermore, in cases where the propagation of vibration is not acceptable, insert vibro-isolating rubber when mounting.

3. Ensure space for maintenance.

When installing and mounting, be sure to allow the space required for maintenance and inspections. Confirm the necessary maintenance space in the instruction manual for each piece of equipment.

4. Do not drop or bump.

Do not drop, bump or apply excessive impact (1000 m/s²) when handling.

5. Never mount in a place which will be used as a scaffold during piping work.

Damage can be caused if subjected to an excessive load.

Piping

⚠ Caution

1. Preparation before piping

Before piping is connected, it should be thoroughly blown out with air (flushing) or washed to remove chips, cutting oil and other debris from inside the pipe.

2. Wrapping of pipe tape

When connecting pipes and fittings, etc., be sure that chips from the pipe threads and sealing material do not get inside the valve. Further, when pipe tape is used, leave 1.5 to 2 thread ridges exposed at the end of the threads.

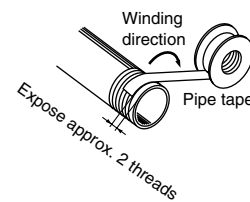

3. Connection of piping to products

When connecting piping to a product, refer to its instruction manual to avoid mistakes regarding the supply port, etc.

4. Observance of tightening threads with the proper tightening torque.

When screwing fittings into valves, tighten with the proper tightening torques as shown below.

PAX1000, PA3000, PA5000

Connection threads	Proper tightening torque (N·m)
Rc 1/4	12 to 14
Rc 3/8	22 to 24
Rc 1/2	28 to 30
Rc 3/4	28 to 30

PB1000

Connection threads	Proper tightening torque (N·m)
M5	1/6 turn after tightening by hand
Rc 1/8	2 to 3

Since the threaded sections of the PB1000 are resin, take particular care not to tighten any more than necessary.

Air Supply

⚠ Warning

1. Do not use compressed air which contains chemicals, organic solvents or corrosive gases.

Do not use compressed air containing chemicals, organic solvents, salt or corrosive gases, as this can cause damage and malfunction, etc.

2. Use within the operating pressure range.

The operating pressure range is determined by the equipment being used. Operation beyond this range can cause damage, failure or malfunction, etc.

VC

VDW

VQ

VX2

VX

VX3

VXA

VN

LVC

LVA

LVH

LVD

LVQ

LQ

LVN

TI/
TIL

PA

PAX

PB

⚠ Precautions 3

Be sure to read before handling. Refer to pages 17-6-3 to 17-6-10 for Safety Instructions and Solenoid Valve Precautions.

Operating Environment

⚠ Warning

1. Do not use in the following environments, as this can cause failure.

- 1) Locations with an atmosphere of corrosive gases, organic solvents or chemical solutions, and where there may be contact with the same.
- 2) Locations where there is contact with sea spray, water or steam.
- 3) Locations where there is contact with direct sunlight. (Sunlight should be blocked to prevent deterioration of resin from ultra violet rays and over heating, etc.)
- 4) Locations near heat sources with poor ventilation. (Heat sources should be blocked off, because radiated heat may cause damage due to softening of materials.)
- 5) Locations with impact or vibration.
- 6) Locations with high moisture and dust.

2. Adhere to the fluid and ambient temperature ranges.

The fluid and ambient temperatures are determined by the equipment being used. Operation beyond this range can cause damage, failure or malfunction, etc.

3. Employ suitable protective measures in locations where there is contact with water droplets, oil or welding spatter, etc.

⚠ Caution

1. Operating environment

- Do not allow corrosive fluids or solvents, etc., to come into contact with the outer surfaces of the pump.
- Do not use in water (or other liquid). Fluid may leak into the pilot switching valve and there may be corrosion of external parts, etc.

2. Low temperature operation

Do not allow freezing. Operation is possible down to an ambient temperature of 0°C, but do not allow solidification or freezing of drainage and moisture, etc.

3. Fluid leakage

- Take measures to deal with leakage. Fluid may leak when the pump is in operation due to aging of the diaphragm, etc. Take measures so that leakage in this type of situation will not have an adverse effect on equipment or personnel.
- Be careful not to touch fluid which has leaked. There is a danger of burns or other injury to the skin if hot fluids or chemicals, etc., are touched.

4. Perform periodic inspections to confirm normal operation.

It may otherwise become impossible to assure safety in the event of unexpected malfunction or misoperation.

Maintenance

⚠ Warning

1. Shut off the compressed air if an abnormality occurs.

Stop the inflow of compressed air if there are abnormalities such as an unusual odor or sound.

2. Set the compressed air pressure to zero when performing maintenance.

In case of disassembly, first confirm that the pressure inside the pump is zero.

⚠ Caution

1. Do not step on or place heavy objects on the unit.

The equipment may be deformed or damaged, and if balance is lost, a fall may cause injury.

2. Discharge drain regularly.

If drain accumulates in equipment, in piping or other areas, this can cause malfunction of the equipment or unexpected trouble due to splash over into the downstream side, etc. Therefore, the amount of drainage and operation of auto drains should be checked every day.

3. Perform maintenance and inspection in accordance with the procedures in the instruction manual.

If handled improperly, this can cause damage or malfunction in machines and equipment, etc.

4. Perform demounting of the product in accordance with the procedures below.

1. Shut off the fluid supply and release the fluid pressure in the system.
2. In the case of the automatically operated type, shut off the air supply and exhaust the compressed air in the pilot piping.
3. Demount the product.

5. Transfer of dangerous fluids.

In case a dangerous fluid such as a strong acid or base is transferred by mistake, do not disassemble the product. There is a danger of serious injury if personnel come into contact with the remaining fluid.

⚠ Precautions 4

Be sure to read before handling. Refer to pages 17-6-3 to 17-6-10 for Safety Instructions and Solenoid Valve Precautions.

Maintenance

⚠ Caution

6. Concerning the life span of diaphragm and the maintenance of consumable items.

- Regular maintenance is required for Diaphragm, Check valve and Switching valve, etc.
- If the diaphragm is not functioning, the operating fluid may flow to the pilot air side and at the same time the operating air may flow out to the liquid circuit. This makes it impossible to restart the operation.
- Consider the pump operation (breathing, decline of discharge pressure, etc.) and reference service life of the diaphragm (referring to the table below) to conduct necessary maintenance as early as possible. With certain operating conditions, check valves and switch valves may experience malfunction earlier than the diaphragm. Please conduct periodic maintenance.
- When conducting maintenance, please use the parts indicated on the parts list (page 17-5-171) and do regular maintenance according to the manual and handling instructions.

* Referential number of the expected life span (Under room temperature, with fresh water)/Volume to be discharged per 1 cycle

Series	Diaphragm material		Volume to be discharged per 1 cycle
	PTFE	NBR	
PA3000 automatically operated type	100 million cycles	50 million cycles	Approx. 40 ml
PA5000 automatically operated type	50 million cycles	50 million cycles	Approx. 100 ml
PA3000 air operated type	50 million cycles	—	Approx. 22 ml
PA5000 air operated type	50 million cycles	—	Approx. 90 ml
PAX1000 built-in attenuator type	50 million cycles	—	Approx. 21 ml
PB1000 built-in solenoid valve type	20 million cycles	—	Approx. 4 to 5 ml

These values are for pilot air pressure of 0.5 MPa, ordinary temperatures, and fresh water, where 1 cycle is one reciprocal motion. This may be shorter depending on the type of fluid and operating conditions, etc.

• Calculation of diaphragm life

Example 1) Discharge rate 5 ℓ/min, when operating 8 h/D (for PAX1000)

$$\frac{\text{Discharge rate}}{\text{Discharge per cycle}} = \frac{5}{0.021} = \frac{238}{(\text{cycles/min})} \text{ Cycles per minute}$$

$$\begin{aligned} \text{Service life} &= \frac{\text{Reference life cycles}}{\text{Cycles per minute}} \times \frac{1}{60} \times \frac{1}{8} \text{ (Daily operating time)} \\ &= \frac{50,000,000}{238} \times \frac{1}{60} \times \frac{1}{8} \\ &= \mathbf{437 \text{ days}} \end{aligned}$$

Example 2) Discharge rate 5 ℓ/min, when operating 8 h/D (for PA3000 automatically operated type)

$$\frac{\text{Discharge rate}}{\text{Discharge per cycle}} = \frac{5}{0.040} = \frac{125}{(\text{cycles/min})} \text{ Cycles per minute}$$

$$\begin{aligned} \text{Service life} &= \frac{\text{Reference life cycles}}{\text{Cycles per minute}} \times \frac{1}{60} \times \frac{1}{8} \text{ (Daily operating time)} \\ &= \frac{100,000,000}{125} \times \frac{1}{60} \times \frac{1}{8} \\ &= \mathbf{1666 \text{ days}} \end{aligned}$$

Example 3) Discharge rate 5 ℓ/min, when operating 8 h/D (for PA5000 automatically operated type)

$$\frac{\text{Discharge rate}}{\text{Discharge per cycle}} = \frac{5}{0.100} = \frac{50}{(\text{cycles/min})} \text{ Cycles per minute}$$

$$\begin{aligned} \text{Service life} &= \frac{\text{Reference life cycles}}{\text{Cycles per minute}} \times \frac{1}{60} \times \frac{1}{8} \text{ (Daily operating time)} \\ &= \frac{50,000,000}{50} \times \frac{1}{60} \times \frac{1}{8} \\ &= \mathbf{2083 \text{ days}} \end{aligned}$$

Lubrication

⚠ Caution

1. The pump does not require lubrication.

In the event that it is lubricated, use turbine oil Class 1 ISO VG32 (with no additives). Refer to the brand names table given below for ISO VG342 sold by each company.

2. Do not lubricate the air operated type.

Turbine Oil Class 1 ISO VG32 (with no additives)

Viscosity classification cst (40°C)	ISO viscosity grade	32
Idemitsu Kosan Co., Ltd.		Turbine oil P-32
Nippon Mitsubishi Oil Corp.		Turbine oil 32(Mitsubishi turbine oil 32)
Cosmo Oil Co., Ltd.		Cosmo turbine 32
Japan Energy Corp.		Kyodo turbine oil 32
Kygnus Sekiyu Co.		Turbine oil 32
Kyushu Oil Co.		Stork turbine 32
Showa Shell Sekiyu K.K.		Turbin oil 32
Tonengeneral Sekiyu K.K.		General R turbine oil 32
Fuji Kosan Co., Ltd.		Fucoal turbine 32

3. Filters and strainers

- Be careful regarding clogging of filters and strainers.
- Replace filter elements after one year of use, or earlier if the amount of pressure drop reaches 0.1 MPa.
- Replace strainers when the amount of pressure drop reaches 0.1 MPa.
- Flush the drain from air filters regularly.

4. Lubrication

If operated with lubrication, be sure to continue the lubrication.

5. Storage

In the case of long term storage after use with water, etc., in thoroughly remove all moisture to prevent rust and deterioration of rubber materials.

VC VDW VQ VX2 VX VX3 VXA VN LVC LVA LVH LVD LVQ LQ LVN TI/
TIL PA PAX PB

Series PA/PAX/PB

⚠ Precautions 5

Be sure to read before handling. Refer to pages 17-6-3 to 17-6-10 for Safety Instructions and Solenoid Valve Precautions.

Fluid Compatibility

⚠ Caution

- Select models by choosing liquid contact materials suitable for the liquids to be transferred.
 - In liquid contact areas, aluminum is suitable for use with oils, and stainless steel is suitable for solvents and industrial water.
 - For the diaphragm material, nitrile rubber is suitable with inert liquids, and fluororesin is suitable with non-permeating liquids.
 - Use fluids which will not corrode the wetted parts materials.
- Transfer examples are shown below. Since the possible applications will change depending on operating conditions, be sure to confirm by means of experimentation.
- These products are not suitable for use in medical applications or with food products.
- Possible applications will change depending on additive agents. Take note of additives.
- Possible applications will change depending on impurities. Take note of impurities.
- Mixing of foreign substances will shorten service life. Operate with foreign substances removed.
- When transferring liquids subject to coagulation, take measures to prevent coagulation inside the pump.

Fluid Compatibility: Series PA3000/5000

Model	PA311 ₀ PA511 ₃	PA3120 PA5120	PA321 ₀ PA521 ₃	PA3220 PA5220
Body material	Aluminum (ADC12)		Stainless steel (SCS14)	
Diaphragm material	Fluoro resin	Nitrile rubber	Fluoro resin	Nitrile rubber
Examples of applicable liquids	Compatible liquids	Turbine oil	Methylethylketone, Acetone Flux, Isopropyl alcohol Inert solvents (High penetration liquids) *	Industrial water Inert solvents
	Incompatible liquids	Cleaning solvents, Water Acids, Bases High permeation liquids High penetration liquids Corrosive liquids	Cleaning solvents, Water Solvents, Acids, Bases High permeation liquids High penetration liquids Corrosive liquids	Corrosive liquids, Acids Bases High permeation liquids High penetration liquids

* The air operated type can also be used for highly permeable liquids. In that case, since the exhaust air will include gas from the fluid which permeates the diaphragm, implement measures to keep the exhaust air from going into the solenoid valve side.

Fluid Compatibility: Series PAX1000

Model	PAX1112	PAX1212
Body material	Aluminum (ADC12)	Stainless steel (SCS14)
Diaphragm material	Fluoro resin	Fluoro resin
Examples of applicable liquids	Compatible liquids	Methylethylketone, Acetone, Flux Isopropyl alcohol, Inert solvents
	Incompatible liquids	Corrosive liquids, Acids, Bases High permeation liquids, High penetration liquids

Fluid Compatibility: Series PB1000

Model	PB1011	PB1013
Body material	Polypropylene (PP), Stainless steel (SUS316)	
Diaphragm material	Fluoro resin	
Examples of applicable liquids	Compatible liquids	Tap water, Detergents, Oils, Ethyl alcohol, Kerosene
	Incompatible liquids	Acids, Bases, Thinners

* Since the PB1011 has a built-in solenoid valve, it cannot be used for transfer of flammable fluids.

Process Pump Built-in Solenoid Valve Type/ Air Operated Type (External Switching Type) Series **PB1000**



JIS Symbol

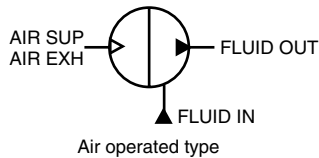
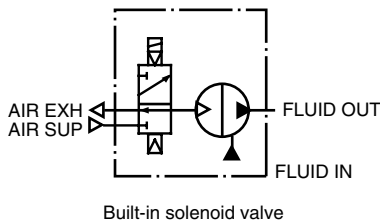

How to Order

PB1 0 1 1 — **01** —

● **Body size**

1	1/8 standard
----------	--------------

● **Body material**

0	Polypropylene
----------	---------------

● **Diaphragm material**

1	PTFE (Fluoro resin)
----------	---------------------

● **Style**

1	Built-in solenoid valve
3	Air operated

● **Option/Part no.**

Nil	Pump only
B	With foot (bolts included) KT-PB1-3
N *	With silencer AN120-M5

* For AIR EXH
Air operated type is not available with silencer (symbol N).

● **Port size**

01	1/8 (6A)
-----------	----------

● **Thread type**

Nil	Rc
T *	NPTF
F *	G
N *	NPT

* T, F, N are options.

Specifications

Model		PB1011	PB1013
Port size	Main fluid suction/discharge port	1/8	
	Pilot air	Supply port	1/8
		Exhaust port	M5 x 0.8
Material	Body wetted areas	Polypropylene PP, Stainless steel (SUS316)	
	Diaphragm	PTFE	
	Check valve	PTFE	
	Liquid contact seals	FKM	
Discharge rate		8 to 2000 ml/min	8 to 500 ml/min
Average discharge pressure		0 to 0.6 MPa	
Suction head		Up to 2.5 m (Dry: Interior of pump dry)	
Fluid temperature		0 to 50°C (No freezing)	
Ambient temperature		0 to 50°C	
Pilot air pressure		0.2 to 0.7 MPa	
Withstand pressure		1.05 MPa	
Recommended operating cycle		1 to 10 Hz (0.03 to 1 Hz also possible depending on conditions ⁽²⁾)	
Lubrication		Not required	
Voltage		24 VDC	—
Weight		0.17 kg	0.15 kg
Mounting position		OUT port at top (Indication on name plate)	
Pilot air solenoid valve recommended Cv factor ⁽¹⁾		—	0.2

* Each value of above represents at normal temperatures with fresh water.

Note on the transfer of slurry:

Slurry transfer is not possible with Series PB1000 because of deterioration and wear of the check valve seat and the accumulation of particles, which will render the pump inoperable.

Note 1) With low operating cycles, even a valve with a small Cv factor can be operated.

Recommended valve/for PB1013 air operated type: SYJ3□4

Note 2) After initial suction of liquid operating at 1 to 7 Hz, it can be used with operation at lower cycles. Since a large quantity of liquid will be pumped out, use a suitable throttle in the discharge port if problems occur.

VC□

VDW

VQ

VX2

VX□

VX3

VXA

VN□

LVC

LVA

LVH

LVD

LVQ

LQ

LVN

TI/
TIL

PA

PAX

PB

Performance Curves: Built-in Solenoid Valve Type/Air Operated Type

Cycle 1 Hz

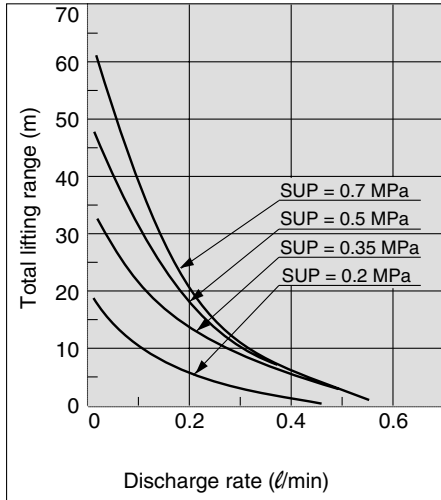

Cycle 5 Hz

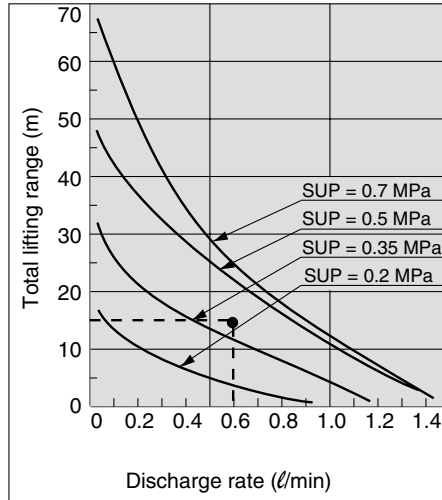

Cycle 10 Hz

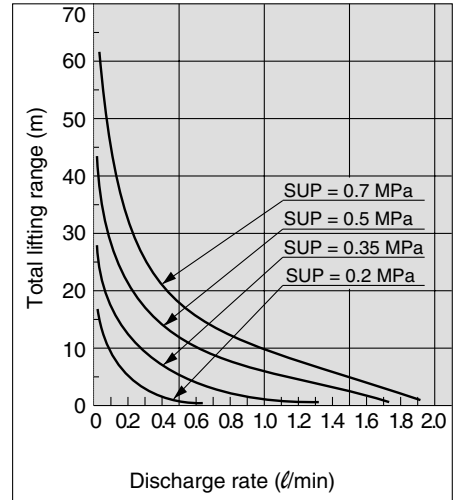

PB1000 Air Consumption

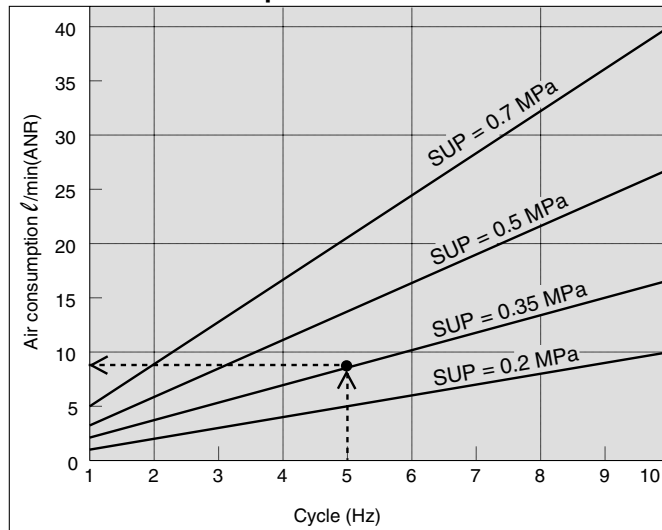

Selection from Flow Characteristic Graph

Required specification example: Find the pilot air pressure and pilot air consumption for a discharge rate of 600 ml/min and a total lifting range of 15 m. <The transferred fluid is clean water (viscosity 1 mPa·s, specific gravity 1.0) solenoid valve cycle 5 Hz>

* If the discharge pressure is required instead of the total lifting height, a total lift of 10 m corresponds to a discharge pressure of 0.1 MPa.

Selection procedure:

1. First mark the intersection point for a discharge rate of 600 ml/min and a lifting range of 15 m.
2. Find the pilot air pressure for the marked point. In this case, the point is between the discharge curves (solid lines) for 0.35 MPa and 0.5 MPa, and based on the proportional relationship to these lines, the pilot air pressure for this point is approximately 0.4 MPa.

Calculating Air Consumption

Find the air consumption for operation with a 5 Hz switching cycle and pilot air pressure of 0.35 MPa from the air consumption graph.

Selection procedure

1. Look up from the 5 Hz switching cycle to find the intersection with SUP = 0.35 MPa.
2. From the point just found, draw a line to the Y-axis to find the air consumption. The result is approximately 9 l/min (ANR).

⚠ Caution

1. These flow characteristics are for fresh water (viscosity 1mPa·s, specific gravity 1.0).
2. The discharge rate differs greatly depending on properties (viscosity, specific gravity) of the fluid being transferred and operating conditions (density, lifting range, transfer distance), etc.
3. If operated continuously at 10 Hz, the diaphragm will reach its service life of 20 million cycles in approximately one month.

Selection from Viscosity Characteristic Graph

Required specification example:

Find the pilot air pressure and pilot air consumption for a discharge rate of 200 ml/min, a total lifting range of 10 m, and a viscosity of 15 mPa·s

Selection procedure:

1. First find the ratio of the discharge rate for fresh water when viscosity is 15 mPa·s from the graph to the left. It is determined to be 48%.
2. Next, the viscosity of 15 mPa·s and the discharge rate of 200 l/min in the required specification example are converted to the discharge rate for fresh water. Since 48% of the fresh water discharge rate is equivalent to 200 ml/min in the required specifications, $200 \text{ ml/min} \div 0.48 = \text{approximately } 420 \text{ ml/min}$, indicating that a discharge rate of 420 ml/min is required for fresh water.
3. Finally, find the pilot air pressure and pilot air consumption based on viewing of the flow characteristics.

Viscosity: Transfer is possible up to about 100 mPa·s.

Dynamic viscosity $\nu = \text{Viscosity } \mu / \text{Density } \rho$.

$$\nu = \frac{\mu}{\rho}$$

$$\nu(10^{-3} \text{m}^2/\text{s}) = \mu(\text{mPa}\cdot\text{s}) / \rho(\text{kg}/\text{m}^3)$$

Viscosity Characteristics

(Flow rate correction for viscous fluids)

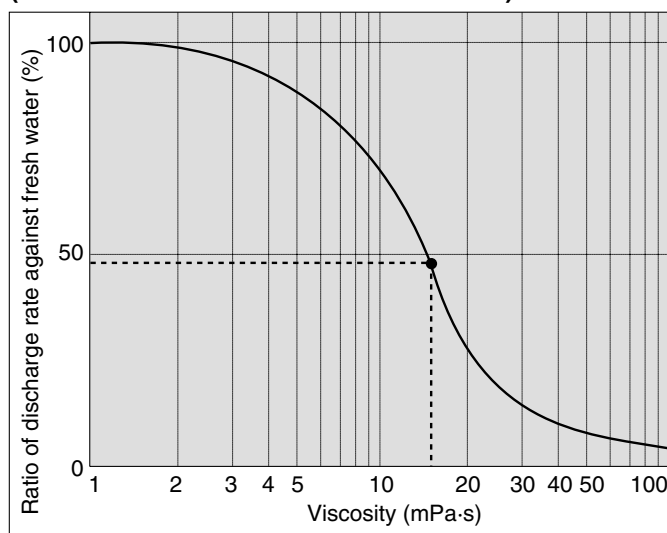

Process Pump: Built-in Solenoid Valve Type/ Air Operated Type (External Switching Type) **Series PB**

Working Principle: Built-in Solenoid Valve Type/Air Operated Type

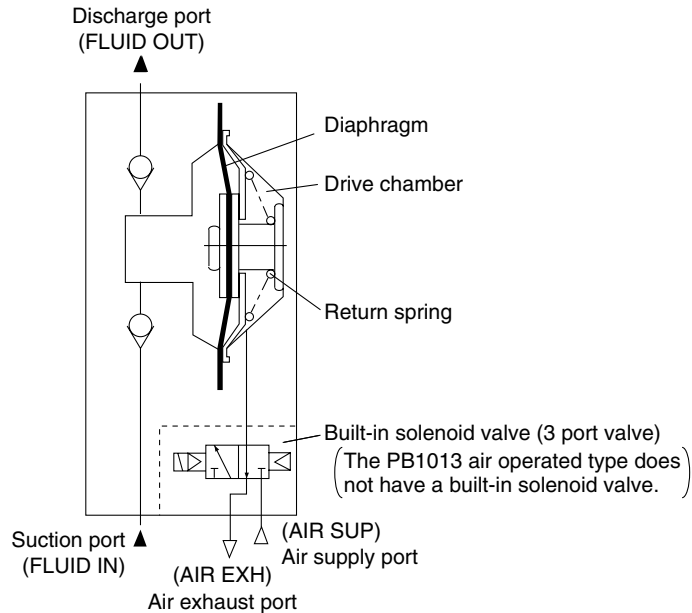

When air is supplied and the built-in solenoid valve is turned ON, air enters the drive chamber and the diaphragm moves to the left. Due to this movement, the fluid in the pump chamber passes through the upper check valve and is discharged to the OUT side.

When the solenoid valve is turned OFF, the air inside the drive chamber is evacuated to EXH, and the diaphragm is moved to the right by the return force of the return spring. Due to this movement, the fluid on the FLUID IN side passes through the lower check valve and is sucked into the pump chamber.

The PB1011 repeats this suction and discharge with the repetition of the built-in solenoid valve's ON/OFF operation. The PB1013 air operated type is operated by the ON/OFF operation of an external solenoid valve.

VC
VDW
VQ
VX2
VX
VX3
VXA
VN
LVC
LVA
LVH
LVD
LVQ
LQ
LVN
TI/ TIL
PA
PAX
PB

Piping and Operation: Built-in Solenoid Valve Type/Air Operated Type

Piping diagram

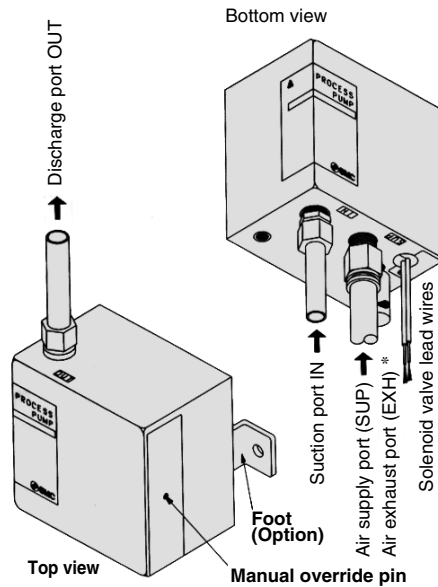

* The PB1013 air operated type has a plug in the air exhaust port EXH.

⚠ Caution

Be sure that the discharge side OUT is on top when the pump is mounted. Supply clean air that has passed through an AF filter, etc., to the air supply port SUP. Air that contains debris or drainage, etc., will have an adverse effect on the built-in solenoid valve, and will cause malfunction of the pump. In cases that particularly require air cleaning, use a filter (Series AF) together with a mist separator (Series AM).

Maintain the proper tightening torque for fittings and mounting bolts, etc.

Looseness can cause problems such as fluid and air leakage, while over tightening can cause damage to threads and parts, etc.

Operation

1. Connect air piping to the air supply port SUP, and connect piping for the transfer fluid to the suction port IN and the discharge port OUT.
2. Connect the solenoid valve lead wires to a 24 VDC power supply. Red is (+) and Black is (-). (The PB1013 air operated type must be equipped with a separate solenoid valve.)
3. Using a regulator, set the pilot air pressure within the range of 0.2 to 0.7 MPa. By continuously turning the 24 VDC power ON/OFF the fluid flows from the suction port IN to the discharge port OUT. The pump performs suction with its own power even without priming.
4. To stop the pump turn OFF the 24 VDC power. Also be sure to turn OFF the power when the discharge side is closed. The manual override pin is used for manual operation when there is no electric power. Each time it is pressed, there is one reciprocal operation.

Circuit example/Built-in solenoid valve

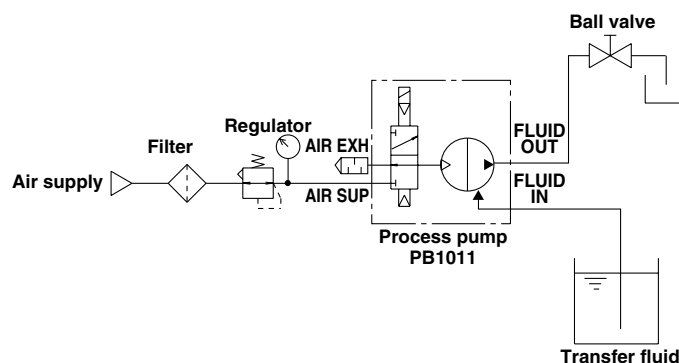

Process Pump: Built-in Solenoid Valve Type/ Air Operated Type (External Switching Type) Series PB

Dimensions

PB1000

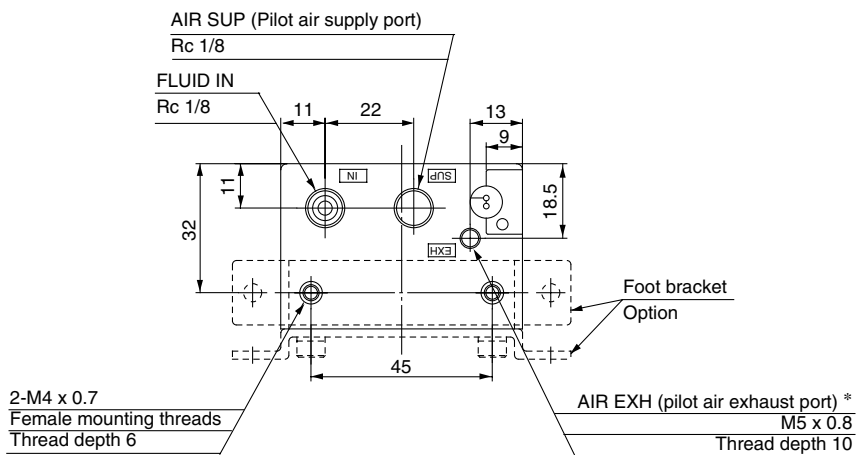
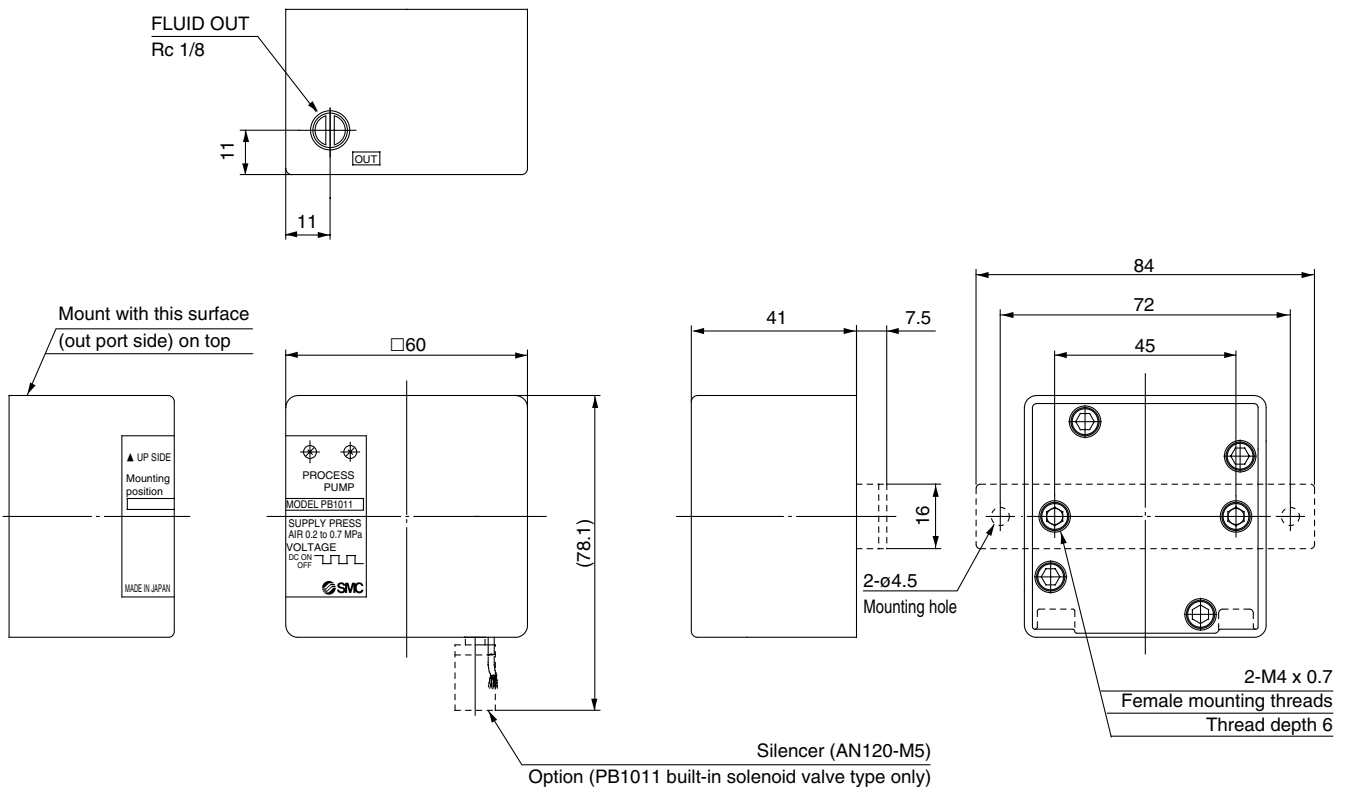

* The PB1013 air operated type has a plug.

- VC□
- VDW
- VQ
- VX2
- VX□
- VX3
- VXA
- VN□
- LVC
- LVA
- L VH
- LVD
- LVQ
- LQ
- LVN
- TI/
TIL
- PA
- PAX
- PB**

SMC Information

Table of Contents (for Back Pages)

- * Safety Instructions
- * 2/3 Port Process Valve Precautions
- * Quality Assurance Information (ISO 9001, ISO 14001)
- * SMC Product Conforming to International Standards
- * Unlisted/Specialized Catalog Information
- * SMC Corporation's Web Site Information
- * Products' INDEX in Alphanumerical Order
- * SMC's Global Service Network



Safety Instructions

These safety instructions are intended to prevent a hazardous situation and/or equipment damage. These instructions indicate the level of potential hazard by labels of "Caution", "Warning" or "Danger". To ensure safety, be sure to observe ISO 4414 ^{Note 1)}, JIS B 8370 ^{Note 2)} and other safety practices.

 **Caution** : Operator error could result in injury or equipment damage.

 **Warning** : Operator error could result in serious injury or loss of life.

 **Danger** : In extreme conditions, there is a possible result of serious injury or loss of life.

Note 1) ISO 4414: Pneumatic fluid power--General rules relating to systems.

Note 2) JIS B 8370: General Rules for Pneumatic Equipment

Warning

1. The compatibility of pneumatic equipment is the responsibility of the person who designs the pneumatic system or decides its specifications.

Since the products specified here are used in various operating conditions, their compatibility for the specific pneumatic system must be based on specifications or after analysis and/or tests to meet your specific requirements. The expected performance and safety assurance will be the responsibility of the person who has determined the compatibility of the system. This person should continuously review the suitability of all items specified, referring to the latest catalog information with a view to giving due consideration to any possibility of equipment failure when configuring a system.

2. Only trained personnel should operate pneumatically operated machinery and equipment.

Compressed air can be dangerous if an operator is unfamiliar with it. Assembly, handling or repair of pneumatic systems should be performed by trained and experienced operators.

3. Do not service machinery/equipment or attempt to remove components until safety is confirmed.

1. Inspection and maintenance of machinery/equipment should only be performed once measures to prevent falling or runaway of the driver objects have been confirmed.
2. When equipment is to be removed, confirm the safety process as mentioned above. Cut the supply pressure for this equipment and exhaust all residual compressed air in the system.
3. Before machinery/equipment is restarted, take measures to prevent shooting-out of cylinder piston rod, etc.

4. Contact SMC if the product is to be used in any of the following conditions:

1. Conditions and environments beyond the given specifications, or if product is used outdoors.
2. Installation on equipment in conjunction with atomic energy, railway, air navigation, vehicles, medical equipment, food and beverages, recreation equipment, emergency stop circuits, clutch and brake circuits in press applications, or safety equipment.
3. An application which has the possibility of having negative effects on people, property, or animals, requiring special safety analysis.



2/3 Port Process Valve Precautions 1

Be sure to read before handling.

For detailed precautions on every series, refer to main text.

Caution on Design

Warning

- 1. Cannot be used as an emergency shutoff valve, etc.**

The valves presented in this catalog are not designed for safety applications such as an emergency shutoff valve. If the valves are used in this type of system, other reliable safety assurance measures should also be adopted.
- 2. Extended periods of continuous energization**

Please consult with SMC if valves will be continuously energized for extended periods of time.
- 3. Solenoid valves are not allowed to use as an explosion proof one.**
- 4. Maintenance space**

The installation should allow sufficient space for maintenance activities (removal of valve, etc.).
- 5. Liquid rings**

In cases with a flowing liquid, provide a by-pass valve in the system to prevent the liquid from entering the liquid seal circuit.
- 6. Operation of actuator**

When an actuator, such as a cylinder, is to be driven using a valve, take appropriate measures to prevent potential danger caused by actuator operation.
- 7. Holding pressure (including vacuum)**

Since the valve may have slight internal air leakage, it may not be suitable for holding pressure (including vacuum) in a tank or other vessel for an extended period of time.
- 8. When the conduit type is used as equivalent to an IP65 enclosure, install a wiring conduit, etc. (Series VC)**

For details, refer to page 17-6-7.

Selection

Warning

- 1. Check the specifications.**

Give careful consideration to operating conditions such as the application, fluid and environment, and use within the operating ranges specified in this catalog.
- 2. Operating fluids**
 - 1) Type of operating fluids**

Select model according to the operating fluid for its material. Viscosity of the operating fluids must be less than 50 cst in general.
Please contact SMC for further information.
 - 2) Flammable oil or gases**

Confirm the specifications for the internal/external leakage.
 - 3) Corrosive gases**

Since corrosive gases may cause stress corrosion, cracking or other accidents, it is not applicable for valves in this catalog.
 - 4) Use a Non-lube valve when impurities such as oil should not be in the fluid passage.**
 - 5) Option and fluids may not be usable on the operating conditions. General use of option and fluids are shown in the catalog to be referred for model selection.**

Selection

Warning

- 3. Quality of operating fluids**

Since the use of fluid which contains foreign matter can cause problems such as malfunction and seal failure by promoting wear of the valve seat and core, and by sticking to the sliding parts of the armature, etc., install a suitable filter (strainer) immediately upstream from the valve. As a general rule, use 80 to 100 mesh.
When used to supply water to boilers, substances such as calcium and magnesium which generate hard scale and sludge are included. Since this scale and sludge can cause valve malfunction, install water softening equipment, and a filter (strainer) directly upstream from the valve to remove these substances.
- 4. Quality of operating air**
 - 1) Use clean air.**

If the compressed air supply includes chemicals, synthetic materials (including organic solvents), salinity, corrosive gas, etc., it can lead to damage or malfunction.
 - 2) Install an air filter.**

Install an air filter at the up stream side to the valve. Filtration degree should be 5 μm or less.
 - 3) Install an air dryer, after cooler, etc.**

Compressed air that includes excessive drainage may cause malfunction of valves and other pneumatic equipment. To prevent this, install an air dryer or after cooler, etc.
 - 4) If excessive carbon powder is seen, install a mist separator on the upstream side of the valve.**

If excessive carbon powder is generated by the compressor, it may adhere to the inside of valves and cause malfunction. For compressed air quality, refer to "Air Cleaning Equipment" catalog.
- 5. Ambient environment**

Operate within the ambient operating temperature range. After confirming the compatibility of the product's component materials with the ambient environment, operate so that fluid does not adhere to the product's exterior surfaces.
- 6. Countermeasures for static electricity**

Since static electricity may be generated depending on the fluid being used, implement suitable countermeasures.



2/3 Port Process Valve Precautions 2

Be sure to read before handling.
For detailed precautions on every series, refer to main text.

Selection

⚠ Caution

1. Leakage voltage

Particularly when using a resistor in parallel with a switching element and using a C-R element (surge voltage suppressor) to protect the switching element, take note that leakage current will flow through the resistor and C-R element, etc., creating a danger that the valve may not shut OFF.

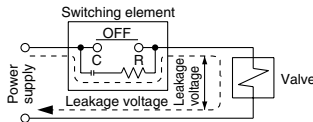

Series VC, VD, VQ

AC coil: 10% or less of rated voltage
DC coil: 2% or less of rated voltage

Series VX

AC coil: 20% or less of rated voltage
DC coil: 2% or less of rated voltage

Series VN

AC coil: 15% or less of rated voltage
DC coil: 3% or less of rated voltage

2. Low temperature operation

- 1) Valve use is possible to temperature extremes of -10°C . Take appropriate measures to avoid freezing of drainage, moisture etc. by using an air dryer.
- 2) When using valves for water application in cold climates, take appropriate countermeasures to prevent the freezing in tubing after cutting the water supply from the pump, e.g. drain the water, etc. When heating by steam, be careful not to expose the coil portion to steam. Installation of dryer, heat retaining of the body are recommended to prevent the freezing in condition that dew-point temperature is high and ambient temperature is low.

Mounting

⚠ Warning

1. If air leakage increases or equipment does not operate properly, stop operation.

Check mounting conditions after air and power supplies are connected. Initial function and leakage tests should be performed after installation.

2. Do not apply external force to the coil section.

Apply spanner to the external connection part when tightening.

3. Avoid installing the coil downward.

Foreign materials in the fluid may stick to the armature and it could cause malfunction. (In the case of VX series)

4. Do not warm the coil assembly part by the heat insulating material, etc.

Tape heater for anti-freezing is applicable to use only for piping or body.

5. Other than fittings made of stainless steel or copper should be tightened with a bracket.

6. Do not use in locations subjected to vibrations. If impossible, arm from the body should be as short as possible to prevent resonance.

7. Instruction manual

Install only after reading and understanding the safety instructions. Keep the catalog on life so that it can be referred to when necessary.

8. Coating

Warnings or specifications indicated on the product should not be erased, removed, or covered up.

Series VQ20/30

When mounting the valve, secure with brackets. When mounting it directly, tighten the mounting screws with the appropriate torque (0.2 to 0.23 N·m).

Mounting screw
Tightening torque 0.2 to 0.23 N·m

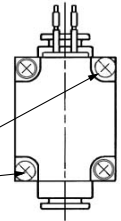

Port Direction

⚠ Caution

1. Preparation before piping

Before piping is connected, it should be thoroughly blown out with air (flushing) or washed to remove chips, cutting oil and other debris from inside the pipe.

Install piping so that it does not apply pulling, pressing, bending or other forces on the valve body.

2. Sealant tape

When installing piping or fitting into a port, ensure that sealant material does not enter the port internally. Furthermore, when sealant tape is used, leave 1.5 to 2 thread ridges exposed at the end of the threads.

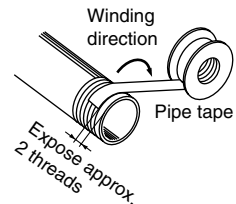

3. Avoid connection of ground lines to piping, as this may cause electric corrosion of the system.

4. Always tighten threads with the proper tightening torque.

When screwing fittings into valves, tighten with the proper tightening torque shown below.

Tightening Torque for Piping

Connection thread	Applicable tightening torque (N·m)
M5	1.5 to 2
Rc 1/8	7 to 9
Rc 1/4	12 to 14
Rc 3/8	22 to 24
Rc 1/2	28 to 30
Rc 3/4	28 to 30
Rc 1	36 to 38
Rc 1 1/4	40 to 42
Rc 1 1/2	48 to 50
Rc 2	48 to 50

* Reference

How to tighten M5 threads on the fittings

After tightening by hand, use a tightening tool to add about 1/6 turn more. But when using miniature fittings, after tightening by hand, use a tightening tool to add 1/4 turn more. (When there are gaskets for universal elbow, universal tee, etc. in 2 locations, tighten them with twice as 1/2 turn.)

5. Connection of piping to products

When connecting piping to a product, avoid mistakes regarding the supply port, etc.

6. Steam generated in a boiler contains a large amount of drainage.

Be sure to operate with a drain trap installed.

7. In applications such as vacuum and non-leak specifications, use caution specifically against the contamination of foreign matters or airtightness of the fittings.



2/3 Port Process Valve Precautions 3

Be sure to read before handling.
For detailed precautions on every series, refer to main text.

Port Direction

⚠ Caution

Series LV

1. Use the tightening torques shown below when making connections to the pilot port.

Operating Port Tightening Torque

Operating port	Torque (N·m)
M5	1/6 turn with a tightening tool after first tightening by hand 0.8 to 1.0
Rc, NPT 1/8	0.8 to 1.0

2. Use of metal fittings

Do not use metal fittings for piping on taper threads made of resin, as this may cause damage to the threads.

3. Use pilot ports and sensor (breathing) ports as indicated below.

	PA Port	PB port	Sensor (breathing) port
N.C.	Pressure	Exhaust	Exhaust
N.O.	Exhaust	Pressure	Exhaust
Double acting	Pressure	Pressure	Exhaust

In the case of N.C. and N.O. types, the port which does not receive operating pressure is released to atmosphere. When intake and exhaust directly from the valve is not desired due to problems with the ambient environment or scattering of dust, etc., install piping and perform intake and exhaust at a location which does not present a problem.

4. For tubing connections, refer to pages 17-5-38 to 39.

Wiring

⚠ Caution

1. Use electrical wires for piping with more than 0.5 to 1.25 mm².
Further, do not allow excessive force to be applied to the lines.
2. Use electrical circuits which do not generate chattering in their contacts.
3. Use voltage which is within 10% of the rated voltage. In cases with a DC power supply where importance is placed on responsiveness, stay within 5% of the rated value. The voltage drop is the value in the lead wire section connecting the coil.
4. When electrical circuit is not acceptable for surge voltage generated by solenoid, install a surge absorber in parallel to the solenoid or use a optional type with surge killer.
(VCB, VCL: Class H coil, Series VCS, VDW, VX, VQ)
5. Series VX, VQ
Use the option with surge voltage suppressor, with surge voltage protection circuit.

Electrical Connections

⚠ Caution

Series VC

Grommet

Class H coil: AWG18
Class B coil: AWG20

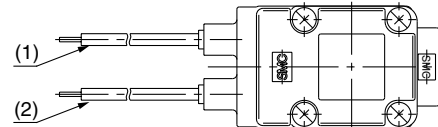

Rated voltage	Lead wire color	
	(1)	(2)
DC (Type B only)	Black	Red
100 VAC	Blue	Blue
200 VAC	Red	Red
Other AC	Gray	Gray

* There is no polarity.

Series VC, VX

DIN terminal (Class B only)

The figure below shows the internal connection of DIN terminal, so connect DIN terminals with power supply.

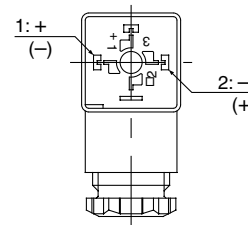

Terminal no.	1	2
DIN terminal	+ (-)	- (+)

* There is no polarity.

- Heavy-duty cord can be used up to the cable O.D. ø6 to 12.
- Use the tightening torques below for each section.

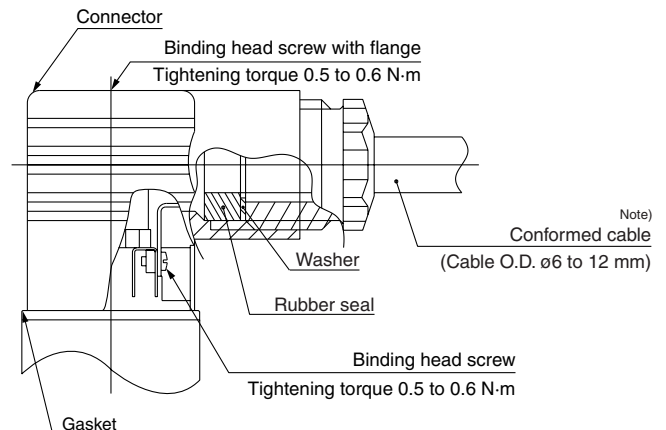

Note) For the one with outside diameter of the cable ø9 to 12 mm, remove the internal parts of the rubber seal before using.



2/3 Port Process Valve Precautions 4

Be sure to read before handling.

For detailed precautions on every series, refer to main text.

Electrical Connections

Warning

Series VC, VX

Conduit terminal

In the case of the conduit terminal, make connections according to the marks shown below.

- Use the tightening torques below for each section.
- Properly seal the terminal connection (G 1/2) with the special wiring conduit, etc.

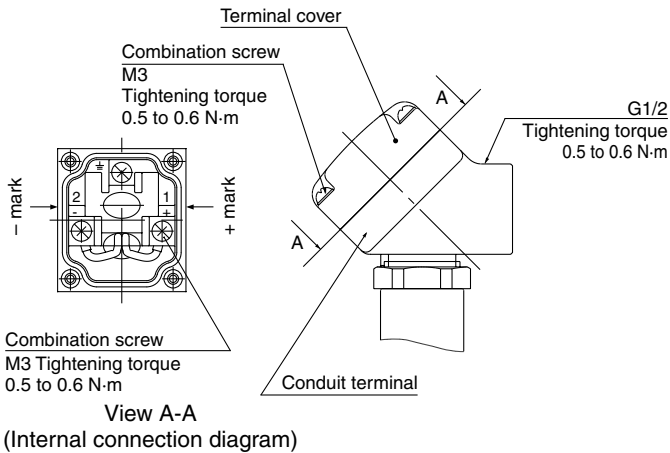

Series VC

Conduit

When used as an IP65 equivalent, use seal (Part no. VCW20-15-6) to install the wiring conduit. Also, use the tightening torque below for the conduit.

Class H coil: AWG18

Class B coil: AWG20

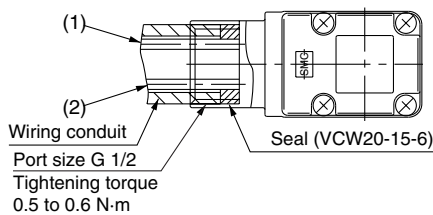

Rated voltage	Lead wire color	
	(1)	(2)
DC	Black	Red
100 VAC	Blue	Blue
200 VAC	Red	Red
Other AC	Gray	Gray

* There is no polarity.

Description	Part no.
Seal	VCW20-15-6

Note) Please order separately.

Series VN

The figures below show the internal connection of DIN terminal or terminal box, so connect them with power supply.

With DIN terminal box

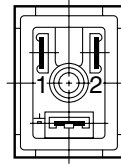

With terminal box

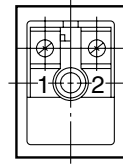

Terminal no.	1	2
DIN terminal	+	-
Terminal	+	-

Connect the conduit terminal according to the marks shown below.

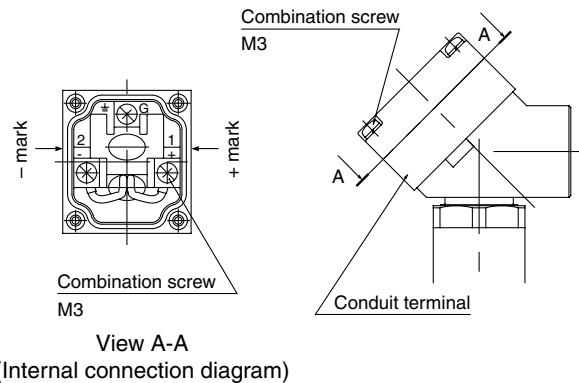



2/3 Port Process Valve Precautions 5

Be sure to read before handling.

For detailed precautions on every series, refer to main text.

Electrical Connections

⚠ Caution

Series VDW

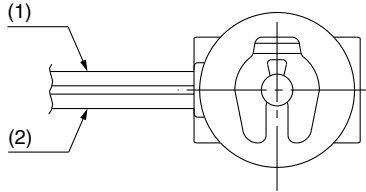

Rated voltage	Lead wire color	
	(1)	(2)
DC	Black	Red
100 VAC	Blue	Blue
200 VAC	Red	Red
Other AC	Gray	Gray

* There is no polarity.

Series VQ20/30

Grommet

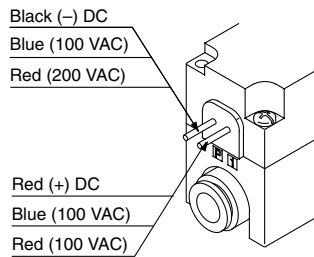

* For energy-saving circuit, there is the polarity.

DIN terminal

Since internal connections are as shown below for the DIN terminal, make connections to the power supply accordingly.

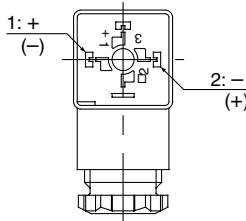

Terminal no.	1	2
DIN terminal	+	-

* For energy-saving circuit, there is the polarity.

Heavy-duty cord can be used up to the cable O.D. $\phi 3.5$ to 7.

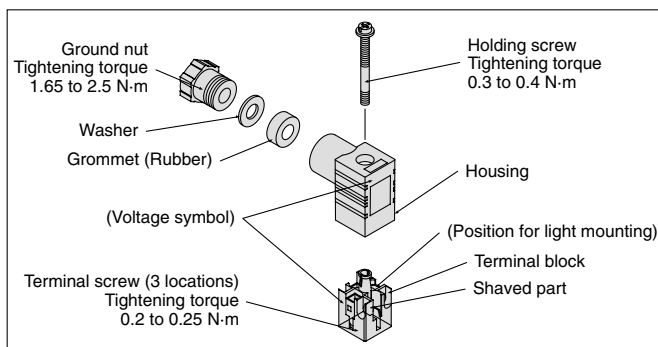

Electrical Circuit

⚠ Caution

Series VC (Class B coil)

Grommet, Conduit, Conduit terminal, DIN connector

DC circuit

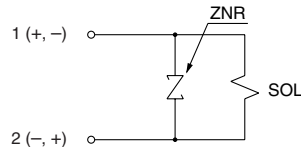

Without indicator light

AC circuit

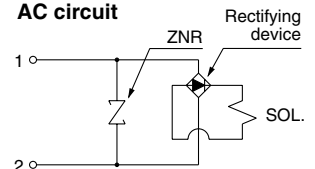

Without indicator light

Conduit terminal, DIN terminal

DC circuit

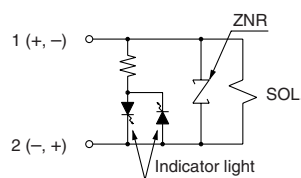

With indicator light

AC circuit

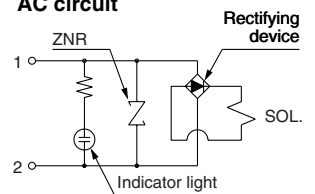

With indicator light

Series VC (Class H coil)

Grommet, Conduit, Conduit terminal

AC circuit

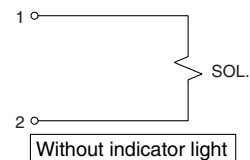

Without indicator light

Series VDW

DC circuit

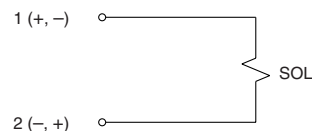

AC circuit

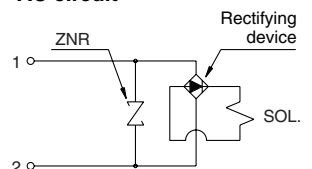



2/3 Port Process Valve Precautions 6

Be sure to read before handling.

For detailed precautions on every series, refer to main text.

Electrical Circuit

Caution

Series VX

Grommet, Conduit, Conduit terminal, DIN connector

DC circuit

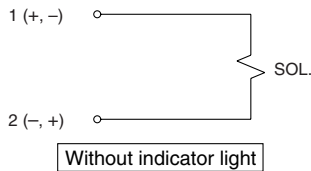

AC circuit

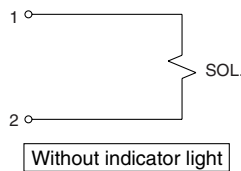

Conduit terminal, DIN terminal

DC circuit

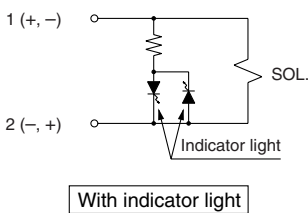

AC circuit

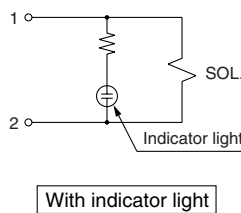

Series VQ20/30

Grommet, DIN terminal

DC voltage (With energy-saving circuit)

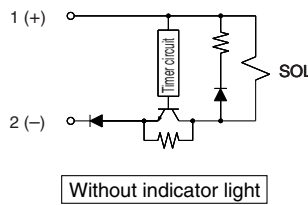

AC circuit

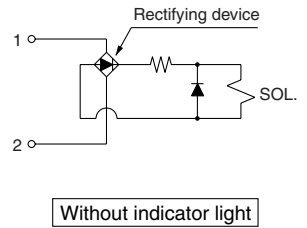

DC circuit

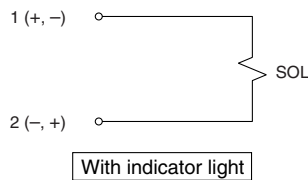

Grommet

DC voltage (With energy-saving circuit)

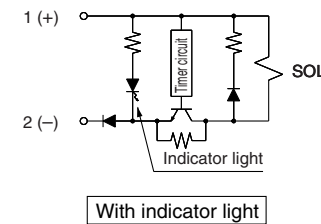

AC circuit

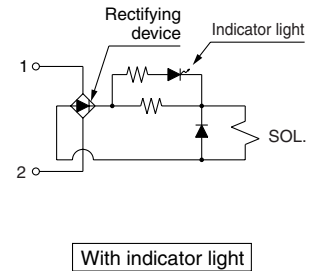

DIN terminal

DC voltage (With energy-saving circuit)

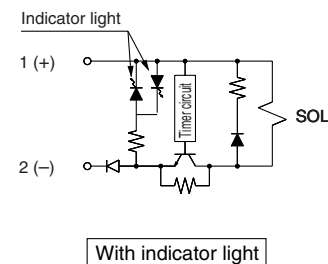

AC circuit

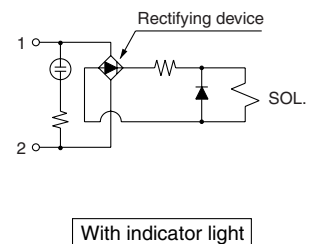



2/3 Port Process Valve Precautions 7

Be sure to read before handling.
For detailed precautions on every series, refer to main text.

Operating Environment

⚠ Warning

1. Do not use valves in atmospheres of corrosive gases, chemicals, salt water, water or steam, or where there is direct contact with same.
2. Do not use in explosive atmospheres.
3. Do not use in locations where vibration or impact occurs.
4. Do not use in locations subject to emissive heat.
5. Employ suitable protective measures in locations where there is contact with water droplets, oil or welding spatter, etc.

Lubrication

⚠ Caution

1. The valve has been lubricated for life at manufacture, and does not require lubrication in service.

If a lubricant is used in the system, use turbine oil Class 1, ISO VG32 (no additive). But do not lubricate the valve with EPR seal.

Refer to the below brand name table of lubricants compliant to Class 1 turbine oil (without additive), ISO VG32.

Class 1 Turbine Oil (with no additive), ISO VG32

Classification of viscosity (cst) (40°C)	Viscosity according to ISO Grade	32
Idemitsu Kosan Co.,Ltd.	Turbine oil P-32	
Nippon Mitsubishi Oil Corp.	Turbine oil 32	
Cosmo Oil Co.,Ltd.	Cosmo turbine 32	
Japan Energy Corp.	Kyodo turbine 32	
Kygnus Oil Co.	Turbine oil 32	
Kyushu Oil Co.	Stork turbine 32	
NIPPON OIL CORPORATION	Mitsubishi turbine 32	
Showa Shell Sekiyu K.K.	Turbine 32	
Tonen General Sekiyu K.K.	General R turbine 32	
Fuji Kosan Co.,Ltd.	Fucoal turbine 32	

Please contact SMC regarding Class 2 turbine oil (with additives), ISO VG32.

Maintenance and Inspection

⚠ Warning

1. Removing the product

The valve will reach high temperatures from high temperature fluids such as steam. Confirm that the valve has cooled sufficiently before performing work. If touched inadvertently, there is a danger of being burned.

- 1) Shut off the fluid supply and release the fluid pressure in the system.
- 2) In the case of air pilot or air-operated type, shut off the supply air source and discharge the compressed air inside a pilot piping.
- 3) Shut off the power supply.
- 4) Remove the product.

2. Remove any remaining chemicals and carefully replace them with pure water or air, etc., before beginning work activities. (Series LV)

3. Low frequency operation

In order to prevent malfunction, conduct a switching operation of a valve every 30 days. Also, in order to use it under the optimum state, conduct a regular inspection once a half year.

4. Manual override

When the manual override is operated, connected equipment will be actuated.

Operate after safety is confirmed.

5. Do not disassemble the product. Products which have been disassembled cannot be guaranteed.

If disassembly is necessary, please contact SMC.

Maintenance and Inspection

⚠ Caution

1. Filters and strainers

- 1) Be careful regarding clogging of filters and strainers.
- 2) Replace filters after one year of use, or earlier if the amount of pressure drop reaches 0.1 MPa.
- 3) Clean the strainer when pressure drop exceeds 0.1 MPa.

2. Lubrication

If operated with lubrication, be sure to continue the lubrication.

3. How to store for a long period of time

Remove water completely from valves before storing for a long period of time to avoid the dust generation and damage to the rubber material.

4. Flush drainage from filters regularly.

Precautions on Handling

⚠ Warning

1. Valves will reach high temperatures from high temperature fluids. Use caution, as there is a danger of being burned if a valve is touched directly.

⚠ Caution

Series LV

1. When the diaphragm is made of PTFE

Please note that when the product is shipped from the factory, gases such as N₂ and air may leak from the valve at a rate of 1 cm³/min (when pressurized).

2. When operated at a very low flow rate, the series LV□ with flow rate adjustment may vibrate, etc. depending on the operating conditions. Therefore, operate it after careful examination of the flow rate, pressure and piping conditions.

3. In the series LV□, water hammering may occur depending on the fluid pressure conditions. In most cases, improvement is possible by adjusting the pilot pressure with a speed controller, etc., but the flow rate, pressure and piping conditions should be reviewed.

4. To adjust the flow rate for the series LV□ with flow rate adjustment, open gradually starting from the fully closed condition.

Opening is accomplished by turning the adjustment knob counterclockwise. It is in the fully closed condition when the product is shipped from the factory.

5. After a long period of nonuse, perform a test run before beginning regular operation.

6. Since the LVC is packaged in a clean room use sufficient care in handling when opened.

Quality Assurance Information (ISO 9001, ISO 14001)

Reliable quality of products in the global market

To enable our customers throughout the world to use our products with even greater confidence, SMC has obtained certification for international standards “ISO 9001” and “ISO 14001”, and created a complete structure for quality assurance and environmental controls. SMC products pursue to meet its customers’ expectations while also considering company’s contribution in society.

Quality management system ISO 9001

This is an international standard for quality control and quality assurance. SMC has obtained a large number of certifications in Japan and overseas, providing assurance to our customers throughout the world.



Environmental management system ISO 14001

This is an international standard related to environmental management systems and environmental inspections. While promoting environmentally friendly automation technology, SMC is also making diligent efforts to preserve the environment.



SMC’s quality control system



Quality policies

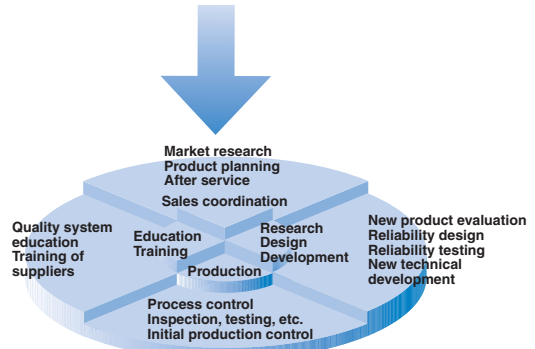

Quality control activities

SMC Product Conforming to Inter

SMC products complying with EN/ISO, CSA/UL standards are supporting



The CE mark indicates that machines and components meet essential requirements of all the EC Directives applied.

It has been obligatory to apply CE marks indicating conformity with EC Directives when machines and components are exported to the member Nations of the EU.

Once "A manufacturer himself" declares a product to be safe by means of CE marking (declaration of conformity by manufacturer), free distribution inside the member Nations of the EU is permissible.

■ CE Mark

SMC provides CE marking to products to which EMC and Low Voltage Directives have been applied, in accordance with CETOP (European hydraulics and pneumatics committee) guide lines.

■ As of February 1998, the following 18 countries will be obliged to conform to CE mark legislation

Iceland, Ireland, United Kingdom, Italy, Austria, Netherlands, Greece, Liechtenstein, Sweden, Spain, Denmark, Germany, Norway, Finland, France, Belgium, Portugal, Luxembourg

■ EC Directives and Pneumatic Components

• Machinery Directive

The Machinery Directive contains essential health and safety requirements for machinery, as applied to industrial machines e.g. machine tools, injection molding machines and automatic machines. Pneumatic equipment is not specified in Machinery Directive. However, the use of SMC products that are certified as conforming to EN Standards, allows customers to simplify preparation work of the Technical Construction File required for a Declaration of Conformity.

• Electromagnetic Compatibility (EMC) Directive

The EMC Directive specifies electromagnetic compatibility. Equipment which may generate electromagnetic interference or whose function may be compromised by electromagnetic interference is required to be immune to electromagnetic affects (EMS/immunity) without emitting excessive electromagnetic affects (EMI/emission).

• Low Voltage Directive

This directive is applied to products, which operate above 50 VAC to 1000 VAC and 75 VDC to 1500 VDC operating voltage, and require electrical safety measures to be introduced.

• Simple Pressure Vessels Directive

This directive is applied to welded vessels whose maximum operating pressure (PS) and volume of vessel (V) exceed 50 bar/L. Such vessels require EC type examination and then CE marking.

national Standards

you to comply with EC directives and CSA/UL standards.



■ CSA Standards & UL Standards

UL and CSA standards have been applied in North America (U.S.A. and Canada) symbolizing safety of electric products, and are defined to mainly prevent danger from electric shock or fire, resulting from trouble with electric products. Both UL and CSA standards are acknowledged in North America as the first class certifying body. They have a long experience and ability for issuing product safety certificate. Products approved by CSA or UL standards are accepted in most states and governments beyond question.

Since CSA is a test certifying body as the National Recognized Testing Laboratory (NRTL) within the jurisdiction of Occupational Safety and Health Administration (OSHA), SMC was tested for compliance with CSA Standards and UL Standards at the same time and was approved for compliance with the two Standards. The above CSA NRTL/C logo is described on a product label in order to indicate that the product is approved by CSA and UL Standards.

■ TSSA (MCCR) Registration Products

TSSA is the regulation in Ontario State, Canada. The products that the operating pressure is more than 5 psi (0.03 MPa) and the piping size is bigger than 1 inch. fall into the scope of TSSA regulation.

Products conforming to CE Standard



With CE symbol for simple visual recognition

In this catalog each accredited product series is indicated with a CE mark symbol. However, in some cases, every available models may not meet CE compliance. Please visit our web site for the latest selection of available models with CE mark.

<http://www.smcworld.com>

SMC's Global Service Network

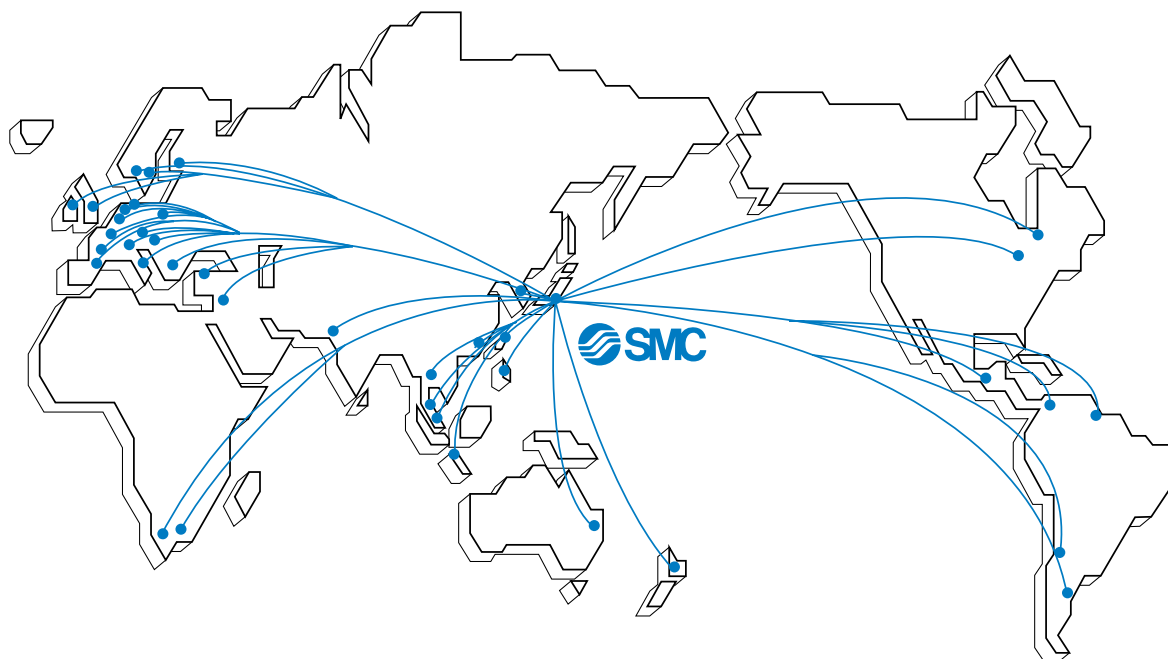

America

U.S.A. **SMC Corporation of America**

3011 North Franklin Road Indianapolis, IN 46226, U.S.A.
TEL: 317-899-4440 FAX: 317-899-3102

CANADA **SMC Pneumatics (Canada) Ltd.**

6768 Financial Drive Mississauga, Ontario, L5N 7J6 Canada
TEL: 905-812-0400 FAX: 905-812-8686

MEXICO **SMC Corporation (Mexico), S.A. DE C.V.**

Carr. Silao-Trejo K.M. 2.5 S/N, Predio San Jose del Duranzo
C.P. 36100, Silao, Gto., Mexico
TEL: 472-72-2-55-00 FAX: 472-72-2-59-44/2-59-46

CHILE **SMC Pneumatics (Chile) S.A.**

Av. La Montaña 1,115 km. 16,5 P. Norte Parque
Industrial Valle Grande, Lampa Santiago, Chile
TEL: 02-270-8600 FAX: 02-270-8601

ARGENTINA **SMC Argentina S.A.**

Teodoro Garcia 3860 (1427) Buenos Aires, Argentina
TEL: 011-4555-5762 FAX: 011-4555-5762

BOLIVIA **SMC Pneumatics Bolivia S.R.L.**

Avenida Beni Numero 4665
Santa Cruz de la Sierra-Casilla de Correo 2281, Bolivia
TEL: 591-3-3428383 FAX: 591-3-3449900

VENEZUELA **SMC Neumatica Venezuela S.A.**

Apartado 40152, Avenida Nueva Granada, Edificio Wanlac,
Local 5, Caracas 1040-A, Venezuela
TEL: 2-632-1310 FAX: 2-632-3871

PERU (Distributor) **IMPECO Automatizacion Industrial S.A.**

AV. Canevaro 752, Lince, Lima, Peru
TEL: 1-471-6002 FAX: 1-471-0935

URUGUAY (Distributor) **BAKO S.A.**

Galicia 1650 esq. Gaboto C.P. 11200, Montevideo, Uruguay
TEL: 2-401-6603 FAX: 2-409-4306

BRAZIL **SMC Pneumaticos Do Brasil Ltda.**

Rua. Dra. Maria Fidelis, nr. 130, Jardim Piraporinha-Diadema-S.P.
CEP: 09950-350, Brasil
TEL: 11-4051-1177 FAX: 11-4071-6636

COLOMBIA (Distributor) **Airmatic Ltda.**

Calle 18 69-05 Apart. Aereo 081045 Santa Fe de Bogotá, Colombia
TEL: 1-424-9240 FAX: 1-424-9260

Europe

U.K. **SMC Pneumatics (U.K.) Ltd.**

Vincent Avenue, Crownhill, Milton Keynes, MK8 0AN, Buckinghamshire, U.K.
TEL: 01908-563888 FAX: 01908-561185

GERMANY **SMC Pneumatik GmbH**

Boschring 13-15 D-63329 Egelsbach, Germany
TEL: 06103-4020 FAX: 06103-402139

ITALY **SMC Italia S.p.A.**

Via Garibaldi 62 I-20061 Carugate Milano, Italy
TEL: 02-9271365 FAX: 02-9271365

FRANCE **SMC Pneumatique S.A.**

1 Boulevard de Strasbourg, Parc Gustave Eiffel, Bussy Saint Georges, F-77600
Marne La Vallee Cedex 3 France
TEL: 01-64-76-10-00 FAX: 01-64-76-10-10

SWEDEN **SMC Pneumatics Sweden AB**

Ekhagsvägen 29-31, S-141 05 Huddinge, Sweden
TEL: 08-603-07-00 FAX: 08-603-07-10

SWITZERLAND **SMC Pneumatik AG**

Dorfstrasse 7, Postfach 117, CH-8484 Weisslingen, Switzerland
TEL: 052-396-3131 FAX: 052-396-3191

AUSTRIA **SMC Pneumatik GmbH (Austria)**

Girakstrasse 8, A-2100 Korneuburg, Austria
TEL: 0-2262-6228-0 FAX: 0-2262-62285

SPAIN **SMC España, S.A.**

Zuazobidea 14 Pol. Ind. Júndiz 01015 Vitoria, Spain
TEL: 945-184-100 FAX: 945-184-510

IRELAND **SMC Pneumatics (Ireland) Ltd.**

2002 Citywest Business Campus, Naas Road, Saggart, Co. Dublin, Ireland
TEL: 01-403-9000 FAX: 01-466-0385

NETHERLANDS (Associated company) **SMC Pneumatics BV**

De Ruyterkade 120, NL-1011 AB Amsterdam, Netherlands
TEL: 020-5318888 FAX: 020-5318880

GREECE (Distributor) **S.Parianopoulos S.A.**

7, Konstantinoupoleos Street 11855 Athens, Greece
TEL: 01-3426076 FAX: 01-3455578

DENMARK **SMC Pneumatik A/S**

Knudsminde 4 B DK-8300
Odder, Denmark
TEL: 70252900 FAX: 70252901

Europe

FINLAND SMC Pneumatics Finland OY

PL72, Tiistinniityntie 4, SF-02231 ESP00, Finland
TEL: 09-8595-80 FAX: 09-8595-8595

NORWAY SMC Pneumatics Norway A/S

Vollsveien 13C, Granfoss Næringspark N-1366 LYSAKER, Norway
TEL: 67-12-90-20 FAX: 67-12-90-21

BELGIUM (Distributor) SMC Pneumatics N.V./S.A.

Nijverheidsstraat 20 B-2160 Wommelgem Belgium
TEL: 03-355-1464 FAX: 03-355-1466

POLAND SMC Industrial Automation Polska Sp.z.o.o.

ul. Konstruktorska 11A, PL-02-673 Warszawa, Poland
TEL: 022-548-5085 FAX: 022-548-5087

TURKEY (Distributor) Entek Pnömatik San.ve Tic. Ltd. Sti

Perpa Tic. Merkezi Kat:11 No.1625 80270 Okmeydani Istanbul, Türkiye
TEL: 0212-221-1512 FAX: 0212-221-1519

RUSSIA SMC Pneumatik LLC.

36/40 Sredny prospect V.O. St. Petersburg 199004, Russia
TEL: 812-118-5445 FAX: 812-118-5449

CZECH SMC Industrial Automation CZ s.r.o.

Hudcova 78a, CZ-61200 Brno, Czech Republic
TEL: 05-4121-8034 FAX: 05-4121-8034

HUNGARY SMC Hungary Ipari Automatizálási kft.

Budafoki ut 107-113 1117 Budapest
TEL: 01-371-1343 FAX: 01-371-1344

ROMANIA SMC Romania S.r.l.

Str. Frunzei, Nr. 29, Sector 2, Bucharest, Romania
TEL: 01-3205111 FAX: 01-3261489

SLOVAKIA SMC Priemyselná automatizácia, s.r.o.

Nova 3, SK-83103 Bratislava
TEL: 02-4445-6725 FAX: 02-4445-6028

SLOVENIA SMC Industrijska Avtomatila d.o.o.

Grajski trg 15, SLO- 8360 Zuzemberk, Slovenia
TEL: 07388-5240 FAX: 07388-5249

LATVIA SMC Pneumatics Latvia SIA

Šmerļa ielā 1-705, Rīga LV-1006
TEL: 777 94 74 FAX: 777 94 75

SOUTH AFRICA (Distributor) Hyflo Southern Africa (Pty.) Ltd.

P.O.Box 240 Paardeneiland 7420 South Africa
TEL: 021-511-7021 FAX: 021-511-4456

EGYPT (Distributor) Saadani Trading & Ind. Services

15 Sebaai Street, Miami 21411 Alexandria, Egypt
TEL: 3-548-50-34 FAX: 3-548-50-34

Oceania/Asia

AUSTRALIA SMC Pneumatics (Australia) Pty.Ltd.

14-18 Hudson Avenue Castle Hill NSW 2154, Australia
TEL: 02-9354-8222 FAX: 02-9894-5719

NEW ZEALAND SMC Pneumatics (New Zealand) Ltd.

8C Sylvia Park Road Mt.Wellington Auckland, New Zealand
TEL: 09-573-7007 FAX: 09-573-7002

TAIWAN SMC Pneumatics (Taiwan) Co.,Ltd.

17, Lane 205, Nansan Rd., Sec.2, Luzhu-Hsiang, Taoyuan-Hsien, TAIWAN
TEL: 03-322-3443 FAX: 03-322-3387

HONG KONG SMC Pneumatics (Hong Kong) Ltd.

29/F, Clifford Centre, 778-784 Cheung, Sha Wan Road, Lai Chi Kok, Kowloon, Hong Kong
TEL: 2744-0121 FAX: 2785-1314

SINGAPORE SMC Pneumatics (S.E.A.) Pte. Ltd.

89 Tuas Avenue 1, Jurong Singapore 639520
TEL: 6861-0888 FAX: 6861-1889

PHILIPPINES SHOKETSU SMC Corporation

Unit 201 Common Goal Tower, Madrigal Business Park, Ayala Alabang Muntinlupa, Philippines
TEL: 02-8090565 FAX: 02-8090586

MALAYSIA SMC Pneumatics (S.E.A.) Sdn. Bhd.

Lot 36 Jalan Delima1/1, Subang Hi-Tech Industrial Park, Batu 3 40000 Shah Alam Selangor, Malaysia
TEL: 03-56350590 FAX: 03-56350602

SOUTH KOREA SMC Pneumatics Korea Co., Ltd.

Woolim e-BIZ Center (Room 1008), 170-5, Guro-Dong, Guro-Gu, Seoul, 152-050, South Korea
TEL: 02-3219-0700 FAX: 02-3219-0702

CHINA SMC (China) Co., Ltd.

7 Wan Yuan St. Beijing Economic & Technological Development Zone 100176, China
TEL: 010-67882111 FAX: 010-67881837

THAILAND SMC Thailand Ltd.

134/6 Moo 5, Tiwanon Road, Bangkok, Amphur Muang, Patumthani 12000, Thailand
TEL: 02-963-7099 FAX: 02-501-2937

INDIA SMC Pneumatics (India) Pvt. Ltd.

D-107 to 112, Phase-2, Extension, Noida, Dist. Gautaim Budh Nagar, U.P. 201 305, India
TEL: (0120)-4568730 FAX: 0120-4568933

INDONESIA (Distributor) P.T. Riyadi Putera Makmur

Jalan Hayam Wuruk Komplek Glodok Jaya No. 27-28 Jakarta 11180 Indonesia
TEL: 021-625 5548 FAX: 021-625 5888

PAKISTAN (Distributor) Jubilee Corporation

First Floor Mercantile Centre, Newton Road Near Boulton Market P.O. Box 6165 Karachi 74000 Pakistan
TEL: 021-243-9070/8449 FAX: 021-241-4589

ISRAEL (Distributor) Baccara Automation Control

Kvutza Geva 18915 Israel
TEL: 04-653-5960 FAX: 04-653-1445

SAUDI ARABIA (Distributor) Assaggaff Trading Est.

P.O. Box 3385 Al-Amir Majed Street, Jeddah-21471, Saudi Arabia
TEL: 02-6761574 FAX: 02-6708173