



Stainless Steel 316 One-touch Fittings

● Material

Metal parts: **Stainless steel 316**
Seal parts: **Special FKM**

● Grease-free

● Fluid temperature

-5 to 150°C

● Can be used with steam.

Addition of applicable tubing (inch) and connection thread (NPT)!



● Applicable tubing material
 · FEP, PFA, Nylon, Soft nylon, Polyurethane
 · Polyolefin

All stainless steel 316 except seal parts

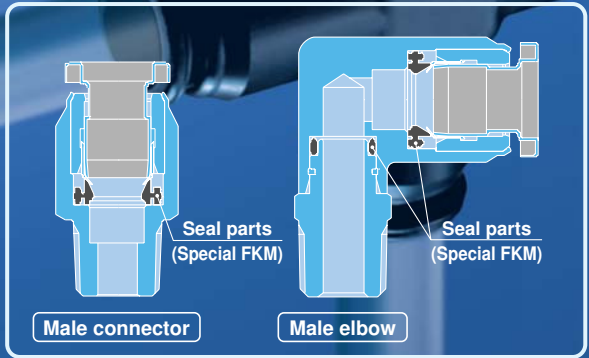

• Certified to meet current Food Sanitation Law standards.
 (Component materials have met apparatuses and container-packages standards, based on Directive 85 of the Japanese Ministry of Health and Safety in 1986.)

Series KQG

Applicable tubing: Metric size/Connection thread: M, R

Male Connector

Applicable tubing O.D. (mm)	Connection thread	Model
ø4	M5	KQGH04-M5
	R1/8	KQGH04-01S
ø6	M5	KQGH06-M5
	R1/8	KQGH06-01S
	R1/4	KQGH06-02S
ø8	R1/8	KQGH08-01S
	R1/4	KQGH08-02S
	R3/8	KQGH08-03S
ø10	R1/4	KQGH10-02S
	R3/8	KQGH10-03S
ø12	R3/8	KQGH12-03S
	R1/2	KQGH12-04S



Hexagon Socket Head Male Connector

Applicable tubing O.D. (mm)	Connection thread	Model
ø4	M5	KQGS04-M5
	R1/8	KQGS04-01S
ø6	M5	KQGS06-M5
	R1/8	KQGS06-01S
	R1/4	KQGS06-02S
ø8	R1/8	KQGS08-01S
	R1/4	KQGS08-02S
	R3/8	KQGS08-03S
ø10	R1/4	KQGS10-02S
	R3/8	KQGS10-03S
ø12	R3/8	KQGS12-03S
	R1/2	KQGS12-04S



Straight Union

Applicable tubing O.D. (mm)	Model
ø4	KQGH04-00
ø6	KQGH06-00
ø8	KQGH08-00
ø10	KQGH10-00
ø12	KQGH12-00



Male Elbow

Applicable tubing O.D. (mm)	Connection thread	Model
ø4	M5	KQGL04-M5
	R1/8	KQGL04-01S
ø6	M5	KQGL06-M5
	R1/8	KQGL06-01S
	R1/4	KQGL06-02S
ø8	R1/8	KQGL08-01S
	R1/4	KQGL08-02S
	R3/8	KQGL08-03S
ø10	R1/4	KQGL10-02S
	R3/8	KQGL10-03S
ø12	R3/8	KQGL12-03S
	R1/2	KQGL12-04S



Union Elbow

Applicable tubing O.D. (mm)	Model
ø4	KQGL04-00
ø6	KQGL06-00
ø8	KQGL08-00
ø10	KQGL10-00
ø12	KQGL12-00



Male Branch Tee

Applicable tubing O.D. (mm)	Connection thread	Model
ø4	M5	KQGT04-M5
	R1/8	KQGT04-01S
ø6	M5	KQGT06-M5
	R1/8	KQGT06-01S
	R1/4	KQGT06-02S
ø8	R1/8	KQGT08-01S
	R1/4	KQGT08-02S
	R3/8	KQGT08-03S
ø10	R1/4	KQGT10-02S
	R3/8	KQGT10-03S
ø12	R3/8	KQGT12-03S
	R1/2	KQGT12-04S



Union Tee

Applicable tubing O.D. (mm)	Model
ø4	KQGT04-00
ø6	KQGT06-00
ø8	KQGT08-00
ø10	KQGT10-00
ø12	KQGT12-00



Union "Y"

Applicable tubing O.D. (mm)	Model
ø4	KQGU04-00
ø6	KQGU06-00
ø8	KQGU08-00
ø10	KQGU10-00
ø12	KQGU12-00



Bulkhead Union

Applicable tubing O.D. (mm)	Model
ø4	KQGE04-00
ø6	KQGE06-00
ø8	KQGE08-00
ø10	KQGE10-00
ø12	KQGE12-00



Stainless Steel 316 One-touch Fittings

Applicable tubing: Metric size/Connection thread: M, R

Series KQG



Applicable Tubing

Tubing material	FEP, PFA, Nylon, Soft nylon ^{Note 1)} , Polyurethane ^{Note 2) Note 3)} , Polyolefin
Tubing O.D.	ø4, ø6, ø8, ø10, ø12

Specifications

Fluid	Air, Water, Steam ^{Note 3) Note 4)}
Operating pressure range ^{Note 5)}	-100 kPa to 1 MPa
Proof pressure	3.0 MPa
Ambient and fluid temperature ^{Note 6)}	-5 to 150°C (No freezing)
Lubricant	Grease-free specification
Seal on the threads	With sealant

Note 1) For soft nylon tubing, water cannot be used.

Note 2) The pulling strength of polyurethane tube is as follows. The pulling load of the tube used for verifying the mounting of the tube within the fitting should be the values as shown or less in the table below. As reference, the thrust force occurring between the tube and the fitting at 0.8 MPa is shown in the table below.

Pulling Strength

Model	TU0425	TU0604	TU0805	TU1065	TU1208
Without inner sleeve	50 N	80 N	110 N	140 N	140 N
With inner sleeve	160 N	180 N	250 N	450 N	500 N

Reference: Thrust Force Occurring at 0.8 MPa

Model	TU0425	TU0604	TU0805	TU1065	TU1208
Load	10 N	25 N	40 N	65 N	90 N

Note 3) Please consult with SMC regarding applicable tube separately.

Note 4) Special FKM that is resistant even when steam is used.

Note 5) Please avoid using in a vacuum holding application such as a leak tester, since there is leakage.

Note 6) It is recommended that you use the inner sleeve in the following conditions:

- When using in an environment where the fluid temperature changes drastically.
- When using at a high temperature.

Temperature Conditions

Operating tube	Temperature
FEP tubing/TH series	80°C or more
PFA tubing/TL series	120°C or more

Spare Parts

Description	Model	Material
Gasket	M-5G3	Stainless steel 316, Special FKM
Bulkhead nut	KQG04-P01	Stainless steel 316
	KQG06-P01	
	KQG08-P01	
	KQG10-P01	
	KQG12-P01	

Tube size O.D.	Model	Tubing model (Material)				Applicable inner sleeve	
		TU (Polyurethane)	TUS (Soft polyurethane)	TH (FEP)	TL (PFA)	Model	Length (mm)
ø4	0402	—	—	●	—	TJG-0402	18
	0425	●	●	●	—	TJG-0425	18
	0403	—	—	—	●	TJG-0403	18
ø6	0604	●	●	●	●	TJG-0604	19
	0805	●	●	—	—	TJG-0805	20.5
ø8	0806	—	—	●	●	TJG-0806	20.5
	1065	●	●	—	—	TJG-1065	23
	1075	—	—	●	—	TJG-1075	23
ø10	1008	—	—	●	●	TJG-1008	23
	1208	●	●	—	—	TJG-1208	24
	1209	—	—	●	—	TJG-1209	24
ø12	1209	—	—	●	—	TJG-1209	24
	1210	—	—	●	●	TJG-1210	24

* Material for the TJG series is stainless steel 316.

Construction

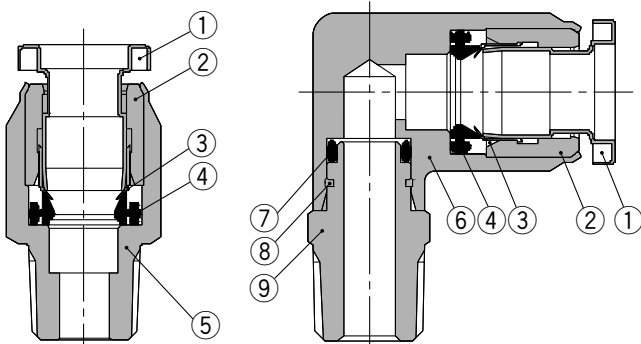

No.	Description	Material
1	Release bushing	Stainless steel 316
2	Guide	Stainless steel 316
3	Chuck	Stainless steel 316
4	Seal	Special FKM (Fluoro coated)
5	Male connector body	Stainless steel 316
6	Male elbow body	Stainless steel 316
7	O-ring	Special FKM (Fluoro coated)
8	Stopper ring	Stainless steel 316
9	Stud	Stainless steel 316

Series KQG

Dimensions

Male Connector: KQGH



Applicable tubing O.D. (mm)	Connection thread R	Model	H (Width across flats)	Note 1) ϕD	L	A*	M	Effective area (mm ²) ^{Note 2)}	Weight (g)
$\phi 4$	M5 x 0.8	KQGH04-M5	10	10	22.3	19.3	18	4	7.4
	1/8	KQGH04-01S			24	20		5.6	9.4
$\phi 6$	M5 x 0.8	KQGH06-M5	12	12	24.1	21.1	18.8	4	11
	1/8	KQGH06-01S			24.3	20.3		10.4	11
	1/4	KQGH06-02S			25.8	19.8		18	
$\phi 8$	1/8	KQGH08-01S	14	14	30.5	26.5	20.9	26.1	18
	1/4	KQGH08-02S			28.5	22.5			18
	3/8	KQGH08-03S			24	17.7			24
$\phi 10$	1/4	KQGH10-02S	17	17	35.5	29.5	23	41.5	29
	3/8	KQGH10-03S			31	24.7			29
$\phi 12$	3/8	KQGH12-03S	19	19	32.8	26.5	24.8	58.3	31
	1/2	KQGH12-04S	22			24.6			51

(In case of M5)

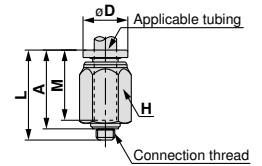

(In case of R)

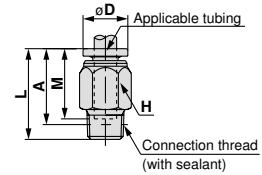

* Reference dimensions after installation of R thread
 Note 1) ϕD is maximum diameter.
 Note 2) Figures shown when using FEP tubing

Hexagon Socket Head Male Connector: KQGS



Applicable tubing O.D. (mm)	Connection thread R	Model	H (Width across flats)	Note 1) ϕD	L	A*	M	Effective area (mm ²) ^{Note 2)}	Weight (g)	
$\phi 4$	M5 x 0.8	KQGS04-M5	2	10	25	22	18	4	8.6	
	1/8	KQGS04-01S	3			21		4.1	9.8	
$\phi 6$	M5 x 0.8	KQGS06-M5	2	12	25.8	22.8	18.8	4	12	
	1/8	KQGS06-01S	4			21.8		9.9	12	
	1/4	KQGS06-02S				19.8		10	20	
$\phi 8$	1/8	KQGS08-01S	5	14	30.5	26.5	20.9	23.3	17.2	
	1/4	KQGS08-02S	6			28.5			22.5	18
	3/8	KQGS08-03S				30.1			23.8	35
$\phi 10$	1/4	KQGS10-02S	8	17	35.5	29.5	23	39	28	
	3/8	KQGS10-03S				31			24.7	29
$\phi 12$	3/8	KQGS12-03S	10	19	32.8	26.5	24.8	60	30	
	1/2	KQGS12-04S				22			24.6	54

(In case of M5)

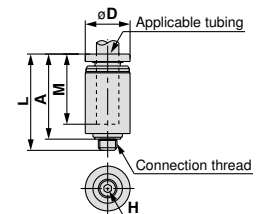

(In case of R)

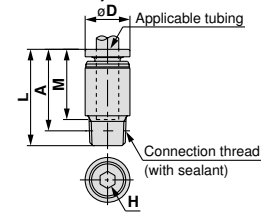

* Reference dimensions after installation of R thread
 Note 1) ϕD is maximum diameter.
 Note 2) Figures shown when using FEP tubing

Straight Union: KQGH



Applicable tubing O.D. (mm)	Model	Note 1) ϕD	L	M	Effective area (mm ²) ^{Note 2)}	Weight (g)
$\phi 4$	KQGH04-00	11	37	18	5.6	16
$\phi 6$	KQGH06-00	13	38	18.5	13.1	22
$\phi 8$	KQGH08-00	15	42.8	20.9	26.1	31
$\phi 10$	KQGH10-00	19	47	23	41.5	54
$\phi 12$	KQGH12-00	21	50.6	24.8	58.3	66

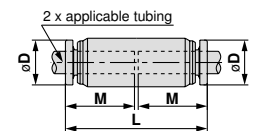

Note 1) ϕD is maximum diameter.
 Note 2) Figures shown when using FEP tubing

Male Elbow: KQGL



Applicable tubing O.D. (mm)	Connection thread R	Model	H (Width across flats)	Note 1) ϕD	L ₁	L ₂	A*	M	Effective area (mm ²) ^{Note 2)}	Weight (g)	
$\phi 4$	M5 x 0.8	KQGL04-M5	10	10.6	20.5	16	18.3	18	3.5	18	
	1/8	KQGL04-01S				19.5	20.8		4.2	20	
$\phi 6$	M5 x 0.8	KQGL06-M5	12	13	22.1	17	20.5	18.8	3.5	25	
	1/8	KQGL06-01S				14	20.5		23	9	26
	1/4	KQGL06-02S					24.5		25	35	
$\phi 8$	1/8	KQGL08-01S	12	15	24.9	21.9	25.4	20.9	21.6	37	
	1/4	KQGL08-02S	14			25.9	27.4			45	
	3/8	KQGL08-03S				27.9	29.1			56	
$\phi 10$	1/4	KQGL10-02S	17	18	27.8	27.7	30.7	23	35.2	69	
	3/8	KQGL10-03S				29.7	32.4			73	
$\phi 12$	3/8	KQGL12-03S	22	20.8	31.3	30.7	35.1	24.8	50.2	94	
	1/2	KQGL12-04S				34.7	37.2			121	

(In case of M5)

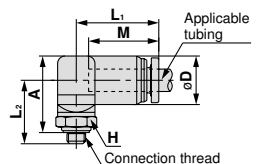

(In case of R)

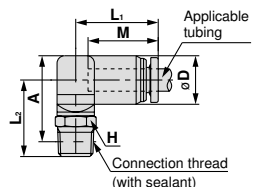

* Reference dimensions after installation of R thread
 Note 1) ϕD is maximum diameter.
 Note 2) Figures shown when using FEP tubing

Dimensions

Union Elbow: KQGL



Applicable tubing O.D. (mm)	Model	Note 1) ϕD	L	A	Q ₁	Q ₂	M	ϕN	Effective area ^{Note 2)} (mm ²)	Weight (g)
$\phi 4$	KQGL04-00	10.6	20.6	27.3	2.3	3.7	18	3.2	4.2	21
$\phi 6$	KQGL06-00	13	22.4	28.9	3.5	3.5	18.8		9	32
$\phi 8$	KQGL08-00	15	25.5	35.1				5	5.6	20.9
$\phi 10$	KQGL10-00	18	28.6	38.2	6.4	6.4	24.8	4.2	23	76
$\phi 12$	KQGL12-00	20.8	31.4	41.8					50.2	108

Note 1) ϕD is maximum diameter.
Note 2) Figures shown when using FEP tubing

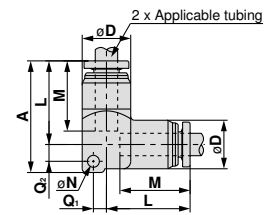

Male Branch Tee: KQGT



Applicable tubing O.D. (mm)	Connection thread R	Model	H (Width across flats)	Note 1) ϕD	L ₁	L ₂	A*	M	Effective area ^{Note 2)} (mm ²)	Weight (g)
$\phi 4$	M5 x 0.8	KQGT04-M5	10	10.6	20.5	18	23.1	18	4.5	26
	1/8	KQGT04-01S				21.5	25.6		6	27
$\phi 6$	M5 x 0.8	KQGT06-M5		13	22.1	19	25	18.8	4.5	39
	1/8	KQGT06-01S				22.5	27.5		11	41
	1/4	KQGT06-02S	26.5			29.5	50			
$\phi 8$	1/8	KQGT08-01S	12	15	24.9	23.9	30.7	20.9	26.3	61
	1/4	KQGT08-02S	27.9			32.7	70			
	3/8	KQGT08-03S	29.9			34.4	83			
$\phi 10$	1/4	KQGT10-02S	17	18	27.8	29.7	35.7	23	40.8	97
	3/8	KQGT10-03S				31.7	37.4		101	
$\phi 12$	3/8	KQGT12-03S	22	20.8	31.3	32.7	39.5	24.8	57.2	133
	1/2	KQGT12-04S				36.7	41.6		159	

* Reference dimensions after installation of R thread
Note 1) ϕD is maximum diameter.
Note 2) Figures shown when using FEP tubing

(In case of M5)

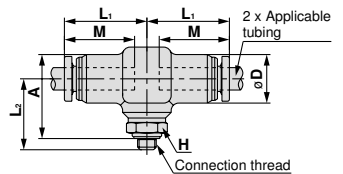

(In case of R)

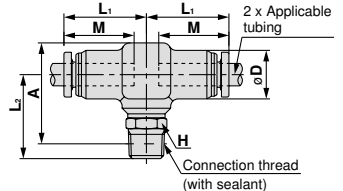

Union Tee: KQGT



Applicable tubing O.D. (mm)	Model	Note 1) ϕD	L	A	Q	M	ϕN	Effective area ^{Note 2)} (mm ²)	Weight (g)
$\phi 4$	KQGT04-00	10.6	20.6	28.7	4.1	18	3.2	6.4	28
$\phi 6$	KQGT06-00	13	22.4	31.4	4.9	18.8		10.6	42
$\phi 8$	KQGT08-00	15	25.5	36.3	6.1	20.9	4.2	25.6	57
$\phi 10$	KQGT10-00	18	28.6	40.6	7.1	23		40	95
$\phi 12$	KQGT12-00	20.8	31.4	44.5	8.1	24.8	57.4	129	

Note 1) ϕD is maximum diameter.
Note 2) Figures shown when using FEP tubing

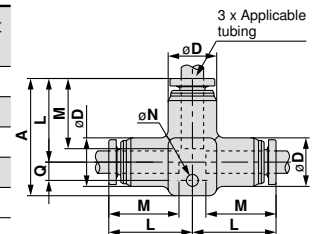

Union "Y": KQGU



Applicable tubing O.D. (mm)	Model	Note 1) ϕD	W	L ₁	L ₂	P	M ₁	M ₂	Effective area ^{Note 2)} (mm ²)	Weight (g)
$\phi 4$	KQGU04-00	10.6	21.2	41	16.8	10.6	18	17	4.2	35
$\phi 6$	KQGU06-00	13	26	42.9	17	13	18.8	17.8	10.6	54
$\phi 8$	KQGU08-00	15	30	47.7	18.7	15	20.9	19.9	25.6	75
$\phi 10$	KQGU10-00	18	36	52.8	20.5	18	23	22	40	114
$\phi 12$	KQGU12-00	20.8	41.6	57.8	21.9	21	24.8	23.8	57.4	175

Note 1) ϕD is maximum diameter.
Note 2) Figures shown when using FEP tubing

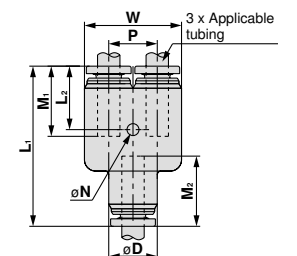

Bulkhead Union: KQGE



Applicable tubing O.D. (mm)	Model	T (M)	H (Width across flats)	L	Mounting hole	M	Effective area ^{Note 2)} (mm ²)	Weight (g)
$\phi 4$	KQGE04-00	M12X1	14	37	13	18	5.6	21
$\phi 6$	KQGE06-00	M14X1	17	38	15	18.5	10.4	29
$\phi 8$	KQGE08-00	M16X1	19	42.8	17	20.9	26.1	40
$\phi 10$	KQGE10-00	M20X1	24	47	21	23	41.5	71
$\phi 12$	KQGE12-00	M22X1	27	50.6	23	24.8	58.3	95

Note) Figures shown when using FEP tubing

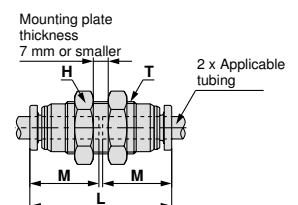

Applicable tubing: Inch size/Connection thread: UNF, NPT

Male Connector

Applicable tubing O.D. (inch)	Connection thread	Model
5/32	10-32UNF	KQGH03-32
	NPT1/8	KQGH03-N01S
1/4	10-32UNF	KQGH07-32
	NPT1/8	KQGH07-N01S
	NPT1/4	KQGH07-N02S
5/16	NPT1/8	KQGH09-N01S
	NPT1/4	KQGH09-N02S
	NPT3/8	KQGH09-N03S
3/8	NPT1/4	KQGH11-N02S
	NPT3/8	KQGH11-N03S
1/2	NPT3/8	KQGH13-N03S
	NPT1/2	KQGH13-N04S



Union Elbow

Applicable tubing O.D. (inch)	Model
5/32	KQGL03-00
1/4	KQGL07-00
5/16	KQGL09-00
3/8	KQGL11-00
1/2	KQGL13-00



Male Branch Tee

Applicable tubing O.D. (inch)	Connection thread	Model
5/32	10-32UNF	KQGT03-32
	NPT1/8	KQGT03-N01S
1/4	10-32UNF	KQGT07-32
	NPT1/8	KQGT07-N01S
	NPT1/4	KQGT07-N02S
5/16	NPT1/8	KQGT09-N01S
	NPT1/4	KQGT09-N02S
	NPT3/8	KQGT09-N03S
3/8	NPT1/4	KQGT11-N02S
	NPT3/8	KQGT11-N03S
1/2	NPT3/8	KQGT13-N03S
	NPT1/2	KQGT13-N04S



Hexagon Socket Head Male Connector

Applicable tubing O.D. (inch)	Connection thread	Model
5/32	10-32UNF	KQGS03-32
	NPT1/8	KQGS03-N01S
1/4	10-32UNF	KQGS07-32
	NPT1/8	KQGS07-N01S
	NPT1/4	KQGS07-N02S
5/16	NPT1/8	KQGS09-N01S
	NPT1/4	KQGS09-N02S
	NPT3/8	KQGS09-N03S
3/8	NPT1/4	KQGS11-N02S
	NPT3/8	KQGS11-N03S
1/2	NPT3/8	KQGS13-N03S
	NPT1/2	KQGS13-N04S



Union Tee

Applicable tubing O.D. (inch)	Model
5/32	KQGT03-00
1/4	KQGT07-00
5/16	KQGT09-00
3/8	KQGT11-00
1/2	KQGT13-00



Straight Union

Applicable tubing O.D. (inch)	Model
5/32	KQGH03-00
1/4	KQGH07-00
5/16	KQGH09-00
3/8	KQGH11-00
1/2	KQGH13-00



Union "Y"

Applicable tubing O.D. (inch)	Model
5/32	KQGU03-00
1/4	KQGU07-00
5/16	KQGU09-00
3/8	KQGU11-00
1/2	KQGU13-00



Male Elbow

Applicable tubing O.D. (inch)	Connection thread	Model
5/32	10-32UNF	KQGL03-32
	NPT1/8	KQGL03-N01S
1/4	10-32UNF	KQGL07-32
	NPT1/8	KQGL07-N01S
	NPT1/4	KQGL07-N02S
5/16	NPT1/8	KQGL09-N01S
	NPT1/4	KQGL09-N02S
	NPT3/8	KQGL09-N03S
3/8	NPT1/4	KQGL11-N02S
	NPT3/8	KQGL11-N03S
1/2	NPT3/8	KQGL13-N03S
	NPT1/2	KQGL13-N04S



Bulkhead Union

Applicable tubing O.D. (inch)	Model
5/32	KQGE03-00
1/4	KQGE07-00
5/16	KQGE09-00
3/8	KQGE11-00
1/2	KQGE13-00



Stainless Steel 316 One-touch Fittings

Applicable tubing: Inch size/Connection thread: UNF, NPT

Series KQG



Applicable Tubing

Tubing material	FEP, PFA, Nylon, Soft nylon ^{Note 1)} , Polyurethane ^{Note 2)} , Polyolefin
Tubing O.D.	ø5/32", ø1/4", ø5/16", ø3/8", ø1/2"

Specifications

Fluid	Air, Water, Steam ^{Note 3)} ^{Note 4)}
Operating pressure range ^{Note 5)}	-100 kPa to 1 MPa
Proof pressure	3.0 MPa
Ambient and fluid temperature ^{Note 6)}	-5 to 150°C (No freezing)
Lubricant	Grease-free specification
Seal on the threads	With sealant

Note 1) For soft nylon tubing, water cannot be used.

Note 2) The pulling strength of polyurethane tube is as follows. The pulling load of the tube used for verifying the mounting of the tube within the fitting should be the values as shown or less in the table below. As reference, the thrust force occurring between the tube and the fitting at 0.8 MPa is shown on the table below.

Pulling Strength

Model	TU0425	TIUB07	TU0805	TIUB11	TIUB13
Without inner sleeve	50 N	80 N	110 N	140 N	140 N
With inner sleeve	160 N	180 N	250 N	450 N	500 N

Reference: Thrust Force Occurring at 0.8 MPa

Model	TU0425	TIUB07	TU0805	TIUB11	TIUB13
Load	10 N	25 N	40 N	65 N	90 N

Note 3) Please consult with SMC regarding applicable tube separately.

Note 4) Special FKM that is resistant even when steam is used.

Note 5) Please avoid using in a vacuum holding application such as a leak tester, since there is leakage.

Note 6) It is recommended that you use the inner sleeve in the following conditions:

- When using in an environment where the fluid temperature changes drastically.
- When using at a high temperature.

Temperature Conditions

Operating tube	Temperature
FEP tubing/TH series	80°C or more
PFA tubing/TL series	120°C or more

Spare Parts

Description	Model	Material
Gasket	M-5G3	Stainless steel 316, Special FKM
Bulkhead nut	KQG03-P01	Stainless steel 316
	KQG07-P01	
	KQG09-P01	
	KQG11-P01	
	KQG13-P01	

Tubing O.D.	Tubing model (Material)			Applicable inner sleeve	
	TU/TIU (Polyurethane)	TH/THI (FEP)	TL/TIL (PFA)	Model	Length (mm)
ø5/32"	—	TH0402	—	TJG-0402	18
	TU0425	TH0425	—	TJG-0425	18
	—	—	TL0403	TJG-0403	18
ø1/4"	—	TH0707	TIL07	TJG-0604	19
	TIUB07	—	—	TJG-0742	19
	—	THA07	—	TJG-0746	19
ø5/16"	TU0805	—	—	TJG-0805	20.5
	—	TH0806	TL0806	TJG-0806	20.5
	—	—	—	TJG-1065	23
ø3/8"	TIUB11	THI11	TIL11	TJG-1107	23
	—	THA11	—	TJG-1384	24
ø1/2"	TIUB13	—	—	TJG-1395	24
	—	THI13	TIL13	TJG-1395	24

Construction

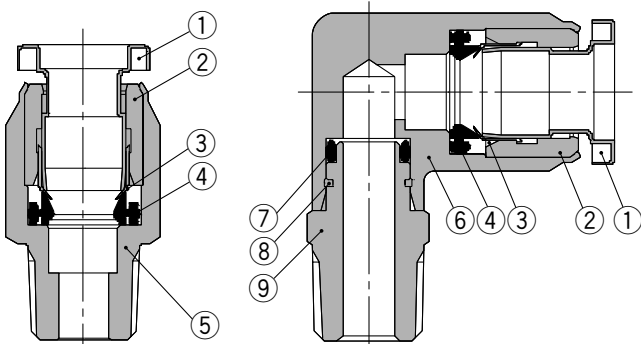

No.	Description	Material
1	Release bushing	Stainless steel 316
2	Guide	Stainless steel 316
3	Chuck	Stainless steel 316
4	Seal	Special FKM (Fluoro coated)
5	Male connector body	Stainless steel 316
6	Male elbow body	Stainless steel 316
7	O-ring	Special FKM (Fluoro coated)
8	Stopper ring	Stainless steel 316
9	Stud	Stainless steel 316

Series KQG

Dimensions

Male Connector: KQGH



Applicable tubing O.D. (inch)	Connection thread NPT	Model	H (Width across flats)	Note 1) ϕD	L	A*	M	Effective area Note 2) (mm ²)	Weight (g)
5/32	10-32UNF	KQGH03-32	10	10	22.3	19.3	18	4	7.4
	NPT1/8	KQGH03-N01S	12		24	19.9		5.6	10
1/4	10-32UNF	KQGH07-32	13	12	24.1	21.1	18.8	4	12
	NPT1/8	KQGH07-N01S			24.3	20.2		10.4	12
	NPT1/4	KQGH07-N02S			25.8	20		18	
5/16	NPT1/8	KQGH09-N01S	14	14	30.5	26.4	20.9	26.1	18
	NPT1/4	KQGH09-N02S			28.5	22.7			18
	NPT3/8	KQGH09-N03S			24	17.9			24
3/8	NPT1/4	KQGH11-N02S	19	17	35.5	29.7	23	41.5	31
	NPT3/8	KQGH11-N03S			31	24.9			31
1/2	NPT3/8	KQGH13-N03S	22	19	32.8	26.7	24.8	58.3	37
	NPT1/2	KQGH13-N04S			24.7	51			

* Reference dimensions after installation of NPT thread Note 1) ϕD is maximum diameter.
Note 2) Figures shown when using FEP tubing

(In case of M5)

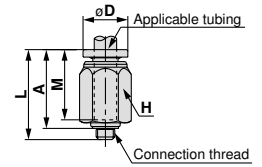

(In case of R)

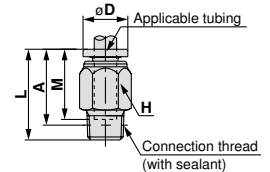

Hexagon Socket Head Male Connector: KQGS



Applicable tubing O.D. (inch)	Connection thread NPT	Model	H (Width across flats)	Note 1) ϕD	L	A*	M	Effective area Note 2) (mm ²)	Weight (g)	
5/32	10-32UNF	KQGS03-32	2.5	10	25	22	18	4	8.6	
	NPT1/8	KQGS03-N01S	2.78	12		20.9		4.1	11	
1/4	10-32UNF	KQGS07-32	4.76	13	25.8	22.8	18.8	4	13	
	NPT1/8	KQGS07-N01S				21.7		9.9	13	
	NPT1/4	KQGS07-N02S				20		10	20	
5/16	NPT1/8	KQGS09-N01S	5.56	14	30.5	26.4	20.9	17.2	17	
	NPT1/4	KQGS09-N02S				28.5		22.7	23.3	18
	NPT3/8	KQGS09-N03S				19		30.1	24	37
3/8	NPT1/4	KQGS11-N02S	6.35	17	35.5	29.7	23	39	28	
	NPT3/8	KQGS11-N03S			19	31			24.9	31
1/2	NPT3/8	KQGS13-N03S	9.53	22	32.8	26.7	24.8	60	36	
	NPT1/2	KQGS13-N04S				24.7			54	

* Reference dimensions after installation of NPT thread Note 1) ϕD is maximum diameter.
Note 2) Figures shown when using FEP tubing

(In case of M5)

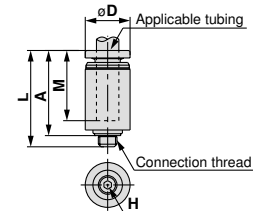

(In case of R)

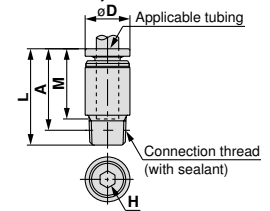

Straight Union: KQGH



Applicable tubing O.D. (inch)	Model	Note 1) ϕD	L	M	Effective area Note 2) (mm ²)	Weight (g)
5/32	KQGH03-00	11	37	18	5.6	16
1/4	KQGH07-00	14	38.6	18.8	13.1	22
5/16	KQGH09-00	15	42.8	20.9	26.1	31
3/8	KQGH11-00	19	47	23	41.5	54
1/2	KQGH13-00	22	50.6	24.8	58.3	66

Note 1) ϕD is maximum diameter.
Note 2) Figures shown when using FEP tubing

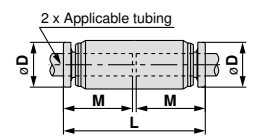

Male Elbow: KQGL



Applicable tubing O.D. (inch)	Connection thread NPT	Model	H (Width across flats)	Note 1) ϕD	L ₁	L ₂	A*	M	Effective area Note 2) (mm ²)	Weight (g)
5/32	10-32UNF	KQGL03-32	10	10.6	20.5	16	18.3	18	3.5	18
	NPT1/8	KQGL03-N01S	12			19.5	20.7		4.2	21
1/4	10-32UNF	KQGL07-32	10	13	22.1	17	20.5	18.8	3.5	25
	NPT1/8	KQGL07-N01S	12			20.5	22.9		9	27
	NPT1/4	KQGL07-N02S	14			24.5	25.2		35	
5/16	NPT1/8	KQGL09-N01S	12	15	24.9	21.9	25.3	20.9	21.6	37
	NPT1/4	KQGL09-N02S				25.9	27.6			45
	NPT3/8	KQGL09-N03S				27.9	29.3			58
3/8	NPT1/4	KQGL11-N02S	19	18	27.8	27.7	30.9	23	35.2	71
	NPT3/8	KQGL11-N03S				29.7	32.6			75
1/2	NPT3/8	KQGL13-N03S	22	20.8	31.3	31	35.3	23.4	50.2	96
	NPT1/2	KQGL13-N04S				35	37.3			121

* Reference dimensions after installation of NPT thread Note 1) ϕD is maximum diameter.
Note 2) Figures shown when using FEP tubing

(In case of M5)

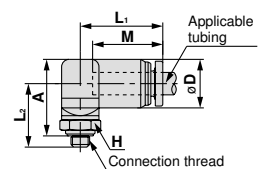

(In case of R)

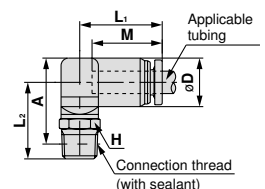

Dimensions

Union Elbow: KQGL



Applicable tubing O.D. (inch)	Model	Note 1) ϕD	L	A	Q ₁	Q ₂	M	ϕN	Effective area ^{Note 2)} (mm ²)	Weight (g)
5/32	KQGL03-00	10.6	20.6	27.3	2.3	3.7	18	3.2	4.2	21
1/4	KQGL07-00	13	22.4	28.9	3.5	3.5	18.8		9	32
5/16	KQGL09-00	15	25.5	35.1				5	5.6	20.9
3/8	KQGL11-00	18	28.6	38.2	6.4	6.4	23.4			
1/2	KQGL13-00	20.8	31.4	41.8				50.2	108	

Note 1) ϕD is maximum diameter.
Note 2) Figures shown when using FEP tubing

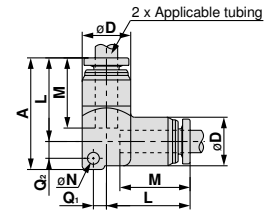

Male Branch Tee: KQGT



Applicable tubing O.D. (inch)	Connection thread NPT	Model	H (Width across flats)	Note 1) ϕD	L ₁	L ₂	A*	M	Effective area ^{Note 2)} (mm ²)	Weight (g)
5/32	10-32UNF	KQGT03-32	10	10.6	20.5	18	23.1	18	4.5	26
	NPT1/8	KQGT03-N01S	12			21.5	25.5		6	28
1/4	10-32UNF	KQGT07-32	10	13	22.1	19	25	18.8	4.5	39
	NPT1/8	KQGT07-N01S	12			22.5	27.4			
	NPT1/4	KQGT07-N02S	14			26.5	29.7		61	
	NPT1/8	KQGT09-N01S	12			23.9	30.6			26.3
5/16	NPT1/4	KQGT09-N02S	14	15	24.9	27.9	32.9	20.9	26.3	
3/8	NPT3/8	KQGT09-N03S	14	18	27.8	29.9	34.6	23	40.8	103
	NPT1/4	KQGT11-N02S	19			29.7	35.9			
1/2	NPT3/8	KQGT11-N03S	19	20.8	31.3	31.7	37.6	23.4	57.2	135
	NPT1/2	KQGT13-N04S	22			32.7	39.7			

* Reference dimensions after installation of NPT thread
Note 1) ϕD is maximum diameter.
Note 2) Figures shown when using FEP tubing

(In case of M5)

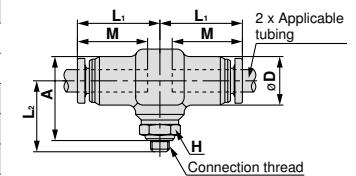

(In case of R)

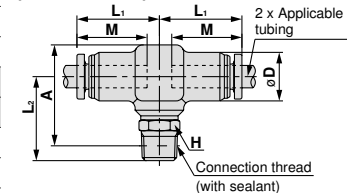

Union Tee: KQGT



Applicable tubing O.D. (inch)	Model	Note 1) ϕD	L	A	Q	M	ϕN	Effective area ^{Note 2)} (mm ²)	Weight (g)
5/32	KQGT03-00	10.6	20.6	28.7	4.1	18	3.2	6.4	28
1/4	KQGT07-00	13	22.4	31.4	4.9	18.8		10.6	42
5/16	KQGT09-00	15	25.5	36.3	6.1	20.9	4.2	25.6	57
3/8	KQGT11-00	18	28.6	40.6	7.1	23		40	95
1/2	KQGT13-00	20.8	31.4	44.5	8.1	23.4	57.4	129	

Note 1) ϕD is maximum diameter.
Note 2) Figures shown when using FEP tubing

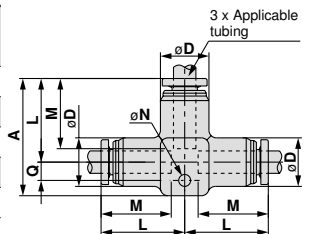

Union "Y": KQGU



Applicable tubing O.D. (inch)	Model	Note 1) ϕD	W	L ₁	L ₂	P	M ₁	M ₂	ϕN	Effective area ^{Note 2)} (mm ²)	Weight (g)
5/32	KQGU03-00	10.6	21.2	41	16.8	10.6	18	17	3.2	4.2	35
1/4	KQGU07-00	13	26.3	42.9	17	13	18.8	17.8		10.6	54
5/16	KQGU09-00	15	30	47.7	18.7	15	20.9	19.9	4.2	25.6	75
3/8	KQGU11-00	18	36	52.8	20.5	18	23	22		40	114
1/2	KQGU13-00	20.8	41.8	57.8	21.9	21	24.8	23.8	57.4	175	

Note 1) ϕD is maximum diameter.
Note 2) Figures shown when using FEP tubing

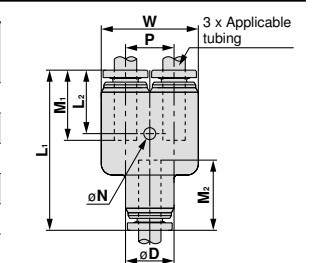

Bulkhead Union: KQGE



Applicable tubing O.D. (inch)	Model	T (M)	H (Width across flats)	L	Mounting hole	M	Effective area ^{Note 2)} (mm ²)	Weight (g)
5/32	KQGE03-00	1/2-20UNF	14	38	13.5	18	5.6	22
1/4	KQGE07-00	9/16-18UNF	17	40.6	15	18.8	10.4	31
5/16	KQGE09-00	3/4-16UNF	22	45.8	20	20.9	26.1	46
3/8	KQGE11-00	7/8-14UNF	26	50	23	23	41.5	76
1/2	KQGE13-00	1-12UNF	29	54.6	26	24.8	58.3	101

Note) Figures shown when using FEP tubing

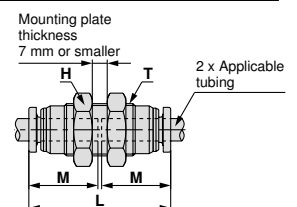



Series **KQG**

Applicable Fluid List

Compatibility Checklist for Used Materials and Fluids

Chemical	Main body	Seal	Chemical	Main body	Seal
	Stainless steel 316	Special FKM		Stainless steel 316	Special FKM
Acrylonitrile	◎	×	Citric acid	◎	—
Acetamide	○	○	Cumene	×	—
Acetaldehyde	◎	×	Glycerin	◎	◎
Acetone	◎	×	Cresol	◎	△
Aniline	○	◎	Chromic acid [10%]	◎	—
Amylene	◎	—	Chlorosulfonic acid	○	×
Sulphurous acid gas (Humid gas)	◎	—	Chlorofluorocarbon (CFC) 11	—	×
Sodium bisulfite [50%]	◎	—	Chlorofluorocarbon (CFC) 113	—	×
Allyl alcohol	◎	—	Chlorofluorocarbon (CFC) 12	○	×
Benzoic acid	◎	—	Chlorofluorocarbon (CFC) 13B1	—	×
Ammonia (Compressed gas)	◎	×	Chlorofluorocarbon (CFC) 14	—	◎
Isopropyl alcohol	○	◎	Chlorofluorocarbon (CFC) 22	○	×
Isophorone	×	—	Chlorobenzene	×	○
Ethyl alcohol	◎	○	Chloroform (Trichloromethane)	○	○
Ethyl ether	○	×	Acetic acid	○	×
Ethylene	◎	—	Amyl acetate	◎	×
Ethylene glycol	×	◎	Isopropyl acetate [20%]	◎	×
Ethylene diamine	◎	—	Ethyl acetate	×	×
Ethylene dichloride	◎	—	Butyl acetate	×	×
Epichlorohydrine	◎	×	Methyl acetate	◎	×
Methyl tertiary butyl ether	—	×	Calcium hypochlorite	◎	—
Allyl chloride	×	—	Sodium hypochlorite [5%]	◎	◎
Ammonium chloride	◎	—	Potassium cyanide [50%]	◎	—
Calcium chloride	◎	—	Copper cyanide	◎	—
Iron(II) chloride [5%]	×	—	Diisobutyl ketone	◎	—
Sodium chloride	○	—	Diisobutylene	—	◎
Magnesium chloride	◎	—	Diethanolamine	◎	—
Hydrochloric acid [5%]	×	—	Diethylamine	×	×
Chlorine gas (Humid gas)	×	—	Diethylene glycol	◎	—
Carbitol	×	—	Carbon tetrachloride	◎	◎
Formic acid [50%]	○	×	Cyclohexanol	×	—
o-Xylene	△	△	Cyclohexanone	×	×
p-Xylene	△	△	Cyclohexane	×	○

Note 1) [] denotes the concentration. Aqueous solutions without condensation notes are in a saturated state.

Note 2) The above data is based on a room temperature of 20°C. Note that you may obtain different figures, depending on temperature conditions.

Note 3) The above data shows compatibility guidelines based upon component parts. Therefore, it is no guarantee of product performance. In addition, using fluids other than those specified in the catalog are not covered by the product's warranty.

How to Read the Table

- ◎ : Completely unaffected or largely unaffected.
- : May be slightly affected, but, dependent upon condition, can sufficiently withstand.
- △ : Advisable to use as little as possible.
- ×
- : Not applicable, as substantially affected.
- : No data is available.

Compatibility Checklist for Used Materials and Fluids

Chemical	Main body	Seal	Chemical	Main body	Seal
	Stainless steel 316	Special FKM		Stainless steel 316	Special FKM
Dichloroethylene	—	△	Butyl phthalate	×	—
Dichlorobenzene	—	△	Butyl alcohol	△	—
Dichloromethane (Methylene chloride)	△	△	Hydrofluoric acid [50%]	◎	—
Ethylene bromide	×	—	Furfurol	×	×
Potassium bromide [30%]	◎	—	n-Propyl alcohol	◎	—
Potassium dichromate [25%]	◎	—	Propylene glycol	◎	—
Oxalic acid	◎	—	Bromochloroethane	—	×
Bromine gas	×	—	n-Hexane	○	◎
Tartaric acid	◎	—	n-Hexyl alcohol	◎	—
Nitric acid [65%]	◎	◎	n-Heptane	◎	—
Ammonium nitrate	◎	—	Benzene	×	×
Ammonium hydroxide	—	○	n-Pentane	×	—
Calcium hydroxide	◎	—	Boric acid	◎	—
Sodium hydroxide [50%]	◎	○	Gallic acid	◎	—
Barium hydroxide	◎	—	Formic aldehyde	◎	×
Solvent naphtha	◎	—	Methyl methacrylate	×	×
Carbonic acid (Humid gas and aqueous solution)	◎	—	Methyl alcohol	◎	○
Tetrachloroethylene	×	◎	Methyl isobutyl ketone	×	×
Tetrahydrofuran	—	×	Methyl ethyl ketone	×	×
Dodecylbenzene	◎	—	Ethyleneglycol monomethyl ether	×	—
Trichloroethane	△	—	Monoethanolamine	◎	—
Trichloroethylene	◎	○	Morpholine	◎	—
Trichloroacetic acid	—	—	Butyric acid	◎	—
Toluene	◎	◎	Hydrogen sulfide (Humid gas and aqueous solution)	◎	×
Naphtha	○	○	Sulphuric acid [10%]	◎	◎
Naphthenic acid	◎	—	Ammonium sulfate	◎	×
Lactic acid	◎	—	Sodium bisulfate [10%]	◎	—
Carbon disulfide	○	◎	Iron(II) sulfate	○	—
Picric acid	◎	—	Sodium sulfate	◎	—
Pyridine	×	×	Phosphoric acid [85%]	◎	—
Phenol	×	○			

Note 1) [] denotes the concentration. Aqueous solutions without condensation notes are in a saturated state.

Note 2) The above data is based on a room temperature of 20°C. Note that you may obtain different figures, depending on temperature conditions.

Note 3) The above data shows compatibility guidelines based upon component parts. Therefore, it is no guarantee of product performance. In addition, using fluids other than those specified in the catalog are not covered by the product's warranty.

How to Read the Table

- ◎: Completely unaffected or largely unaffected.
- : May be slightly affected, but, dependent upon condition, can sufficiently withstand.
- △: Advisable to use as little as possible.
- ×: Not applicable, as substantially affected.
- : No data is available.





Series **KQG**

Safety Instructions

These safety instructions are intended to prevent a hazardous situation and/or equipment damage. These instructions indicate the level of potential hazard by labels of "Caution", "Warning" or "Danger". To ensure safety, be sure to observe ISO 4414 ^{Note 1)}, JIS B 8370 ^{Note 2)} and other safety practices.

■ Explanation of the Labels

Labels	Explanation of the labels
 Danger	In extreme conditions, there is a possible result of serious injury or loss of life.
 Warning	Operator error could result in serious injury or loss of life.
 Caution	Operator error could result in injury ^{Note 3)} or equipment damage. ^{Note 4)}

Note 1) ISO 4414: Pneumatic fluid power – General rules relating to systems

Note 2) JIS B 8370: General Rules for Pneumatic Equipment

Note 3) Injury indicates light wounds, burns and electrical shocks that do not require hospitalization or hospital visits for long-term medical treatment.

Note 4) Equipment damage refers to extensive damage to the equipment and surrounding devices.

■ Selection/Handling/Applications

1. The compatibility of the pneumatic equipment is the responsibility of the person who designs the pneumatic system or decides its specifications.

Since the products specified here are used in various operating conditions, their compatibility for the specific pneumatic system must be based on specifications or post analysis and/or tests to meet the specific requirements. The expected performance and safety assurance are the responsibility of the person who has determined the compatibility of the system. This person should continuously review the suitability of all items specified, referring to the latest catalog information with a view to giving due consideration to any possibility of equipment failure when configuring a system.

2. Only trained personnel should operate pneumatically operated machinery and equipment.

Compressed air can be dangerous if handled incorrectly. Assembly, handling or repair of pneumatic systems should be performed by trained and experienced operators. (Understanding JIS B 8370 General Rules for Pneumatic Equipment, and other safety rules are included.)

3. Do not service machinery/equipment or attempt to remove components until safety is confirmed.

1. Inspection and maintenance of machinery/equipment should only be performed once measures to prevent falling or runaway of the driven objects have been confirmed.
2. When equipment is removed, confirm that safety process as mentioned above. Turn off the supply pressure for this equipment and exhaust all residual compressed air in the system, and release all the energy (liquid pressure, spring, condenser, gravity).
3. Before machinery/equipment is restarted, take measures to prevent quick extension of a cylinder piston rod, etc.

4. If the equipment will be used in the following conditions or environment, please contact SMC first and be sure to take all necessary safety precautions.

1. Conditions and environments beyond the given specifications, or if product is used outdoors.
2. Installation on equipment in conjunction with atomic energy, railway, air navigation, vehicles, medical equipment, food and beverages, recreation equipment, emergency stop circuits, clutch and brake circuits in press applications, or safety equipment.
3. An application which has the possibility of having negative effects on people, property, requiring special safety analysis.
4. If the products are used in an interlock circuit, prepare a double interlock style circuit with a mechanical protection function for the prevention of a breakdown. And, examine the devices periodically if they function normally or not.

■ Exemption from Liability

1. SMC, its officers and employees shall be exempted from liability for any loss or damage arising out of earthquakes or fire, action by a third person, accidents, customer error with or without intention, product misuse, and any other damages caused by abnormal operating conditions.

2. SMC, its officers and employees shall be exempted from liability for any direct or indirect loss or damage, including consequential loss or damage, loss of profits, or loss of chance, claims, demands, proceedings, costs, expenses, awards, judgments and any other liability whatsoever including legal costs and expenses, which may be suffered or incurred, whether in tort (including negligence), contract, breach of statutory duty, equity or otherwise.

3. SMC is exempted from liability for any damages caused by operations not contained in the catalogs and/or instruction manuals, and operations outside of the specification range.

4. SMC is exempted from liability for any loss or damage whatsoever caused by malfunctions of its products when combined with other devices or software.



Series KQG

Specific Product Precautions 1

Be sure to read this before handling.

For Safety Instructions, refer to the back of page 1 and for Fittings & Tubing Precautions, refer to "Precautions for Handling Pneumatic Devices" (M-03-E3A).

Selection

⚠ Caution

1. Do not use in locations where the connecting threads and tubing connection will slide or rotate.

The connecting threads and tubing connection will come apart under these conditions, or the fitting may be broken.

2. Consult with SMC regarding fluids other than air, water and steam.

3. In case of liquid fluids, keep surge pressure at or below the maximum operating pressure.

If the surge pressure exceeds the maximum operating pressure, damage to the fittings and tubing may occur.

4. Do not use this product in an environment where a foreign matter can adhere to the product or get inside of the product.

This may cause air leakage or permit tube to release from fitting.

5. The pulling strength of polyurethane tube is as follows. The pulling load of the tube used for verifying the mounting of the tube within the fitting should be the values as shown or less in the table below. As reference, the thrust force occurring between the tube and the fitting at 0.8 MPa is shown on the table below.

Pulling Strength

Model	TU0425	TU0604 TIUB07	TU0805	TU1065 TIUB11	TU1208 TIUB13
Without inner sleeve	50 N	80 N	110 N	140 N	140 N
With inner sleeve	160 N	180 N	250 N	450 N	500 N

Reference: Thrust Force Occurring at 0.8 MPa

Model	TU0425	TU0604 TIUB07	TU0805	TU1065 TIUB11	TU1208 TIUB13
Load	10 N	25 N	40 N	65 N	90 N

6. If using water, it is recommended to use an inner sleeve. (Tube may release due to pressure pulsation or water hammer effect.)

7. If using a fluoro-resin tube in an environment where the fluid temperature changes drastically, it is recommended to use an inner sleeve. Otherwise, air leakage may occur or the tube may release from fitting due to deformation of the tube.

Mounting

⚠ Caution

1. Before mounting, please confirm that the model, size, etc. are correct.

In addition, please confirm that there are no blemishes, nicks or cracks in the product.

2. When tubing is connected, consider factors such as changes in the tubing length due to pressure, and give adequate space.

3. Mount so that the fittings and tubing are not subjected to strain or moment loads.

This can cause damage to the fittings and flattening, bursting or disconnection of the tubing, etc.

4. Mount so that tubing is not damaged due to tangling and abrasion.

This can cause flattening, bursting or disconnection of the tubing, etc.

5. The union elbow, union tee and union "Y" should be fixed through the mounting hole.

Otherwise, air leakage or breaking can occur due to a pulling force or moment load created by the product's weight.

6. It is recommended that use of tube be with the minimum bending radius or more.

Otherwise, the tube may fold or can be squeezed.

Installation of Threads

⚠ Caution

1. For M5 and 10-32UNF

Tighten the screw within 1.0 to 1.5 N·m of the proper tightening torque. As a guide, after tightening by hand, tighten approximately 1/6 turn further using a tightening tool. Excessive tightening can cause air leakage due to thread damage or deformation of the gasket, etc. Insufficient tightening can cause loose threads and air leakage, etc.

2. Taper threads

When installing, tighten with the proper torque shown in the table below. As a rule, this corresponds to two or three turns with a tool after being tightened by hand.

Connection thread size	Proper tightening torque (N·m)
NPT, R1/8	7 to 9
NPT, R1/4	12 to 14
NPT, R3/8	22 to 24
NPT, R1/2	28 to 30

3. Tightening tools

Tighten with an appropriate wrench using the hexagon wrench flats on the body.

Tighten by placing an appropriate wrench firmly against the fitting body. Position the wrench on the base as close as possible to the threads. If the wrench size is not correct, the fitting body may be damaged.



Series KQG

Specific Product Precautions 2

Be sure to read this before handling.

For Safety Instructions, refer to the back of page 1 and for Fittings & Tubing Precautions, refer to "Precautions for Handling Pneumatic Devices" (M-03-E3A).

Installation and Removal of Tubing

Caution

1. Installation of tubing

- 1) Take a tube having no flaws on its periphery and cut it off at a right angle. Do not use pinchers, nippers or scissors, etc. The tubing might be cut diagonally or flattened, making installation impossible or causing problems such as disconnection and leakage.
- 2) Hold the tubing and slowly insert it all the way into the fitting.
- 3) After inserting the tubing, pull on it lightly to confirm that it will not come out. If it is not securely installed all the way into the fitting, problems such as leakage or disconnection of the tubing can occur.
- 4) Grease is not used for the KQG series, therefore a greater insertion force is required when the tubing is installed. In particular, polyurethane tubing may fold when inserted due to its softness. Hold the end of the tubing, and insert it all the way in slowly and securely. Refer to dimension "M" in the dimension drawings for guidance on the insertion depth of tubing.

2. Removal of tubing

- 1) Sufficiently depress the release bushing and tubing, making sure to apply even pressure around the release bushing.
- 2) Pull out the tubing while depressing the release bushing so that it does not pop out. If the release bushing is not depressed sufficiently, there will be an increased bite on the tubing and it will become more difficult to pull out.
- 3) When the removed tubing is reused, first cut off the section of the tubing which has been clamped. Reusing the clamped portion of the tubing can cause problems such as leakage, difficulties in removal, etc. In addition, for tubing used at a high temperature or for an extended period of time, there is a possibility that it will not fit into a one-touch fitting again due to an enlarged O.D. Dispose of the tubing and replace it with a new one.

Operating Environment

Warning

1. Do not use in environments or locations where there is a danger of damage to the fittings and tubing.

For fitting and tubing materials, refer to specifications and construction drawings, etc.

2. Do not operate in locations where vibration or impact occurs because this can cause leakage, damage to fittings, etc.

Please contact SMC regarding use in these environments.

3. Do not use this product in an environment where a foreign matter can adhere to the product or get inside of the product.

This may cause air leakage or permit tube to release from fitting.

Maintenance

Caution

1. Pre-maintenance inspection

When the product is removed, turn off the power, cut off the supply pressure, and confirm that fluid in the piping has been discharged.

2. During regular maintenance, check for the following and replace any components as necessary.

- a) Scratches, gouges, abrasion, corrosion
- b) Leakage
- c) Flattening or distortion of tubing
- d) Hardening, deterioration or softness of tubing

3. Do not repair the fittings or patch the tubing for reuse.

Precautions on Use of Other Tubing Brands

Caution

1. Our product warranty is not valid if tubing brands other than from SMC are used.



Record of changes

B edition	* Error correction: Union "Y" Dimensions Bulkhead Union Dimensions on page 3 * Number of pages from 8 to 12.	JX
C edition	* Addition of applicable tubing (Inch) and connection thread (UNF and NPT). * Number of pages 12 to 16.	LT

 **Safety Instructions** Be sure to read "Precautions for Handling Pneumatic Devices" (M-03-E3A) before using.

SMC Corporation

Akihabara UDX 15F,
4-14-1, Sotokanda, Chiyoda-ku, Tokyo 101-0021, JAPAN
Phone: 03-5207-8249 FAX: 03-5298-5362
URL <http://www.smcworld.com>
© 2007 SMC Corporation All Rights Reserved

Specifications are subject to change without prior notice
and any obligation on the part of the manufacturer.

D-DN

1st printing IU printing LT 13500DN Printed in Japan.

This catalog is printed on recycled paper with concern for the global environment.