

Heatless Air Dryer Series ID

Heatless ID series is best when dry air with a low dew point is needed.

Supply dry air with a low dew point below -30°C .

Compact and lightweight without heater and electric control board.

Possible to check the outlet dew point with the indicator.

(Self-regenerative style allows for easy maintenance.)



Model

Model	ID20□	ID30□	ID40□	ID60□
Outlet air flow rate (L/min (ANR))	80	155	330	780
Recycled air flow rate ^{Note)} (L/min (ANR))	20	37	85	195
Inlet air flow rate (L/min (ANR))	100	192	415	975
Port size (Nominal size B)	1/4	1/2	1/2	3/4
Weight (kg)	7	8.5	18.5	25

Note) Inlet air pressure: In the case of 0.7 MPa

Specifications

Model	ID20□	ID30□	ID40□	ID60□
Fluid	Compressed air			
Operating pressure (MPa)	0.3 to 1.0		0.3 to 0.9	
Inlet air temperature ($^{\circ}\text{C}$)	5 to 50			
Ambient temperature ($^{\circ}\text{C}$)	2 to 50			
Power supply voltage	Refer to How to Order.			
Power consumption	30 W			
Installation features	Indoor			

Note) Inlet air pressure: 0.7 MPa, Inlet air temperature: 35°C , Outlet air dew point (atmospheric pressure): -30°C

Semi-standard (Option Z) Specifications

Model	ID20□	ID30□	ID40□	ID60□
Outlet air atmospheric pressure dew point	-50°C ^{Note)}			

Note) When the refrigerated air dryer is installed on the inlet side. (Inlet air pressure: 0.7 MPa, Inlet air temperature: 20°C)

Accessory (Option)/Replacement Parts

Applicable model	ID20□	ID30□	ID40□	ID60□
Bracket	6604113	6604113	660651	660651
Adsorbent set ^{Note)}	ID-200S	ID-300S	ID-400S	ID-600S
Adsorbent set (for low dew point) ^{Note)}	ID-200Z	ID-300Z	ID-400Z	ID-600Z
Indicator set	ID-DPM8			

Note) Adsorbent and adsorption tube filter for one air dryer (two adsorption tubes), set of O-rings

How to Order

ID 20 0 - 02 □

Basic size

20
30
40
60

Power supply voltage

Symbol	Description
0	Single phase 100 VAC (50 Hz) 100 to 110 VAC (60 Hz)
1	Single phase 110 VAC (50 Hz)
5	Single phase 200 VAC (50 Hz) 200 to 220 VAC (60 Hz)
6	Single phase 220 VAC (50 Hz)

Semi-standard (option)

Symbol	Description
NII	—
B	Bracket
Z	Adsorbent for low dew point

Port size

Symbol	Size	Applicable standard size			
		20	30	40	60
02	1/4	●			
04	1/2		●	●	
06	3/4				●

Thread type

Symbol	Type
NII	Rc
F	G
N	NPT

Working Principle

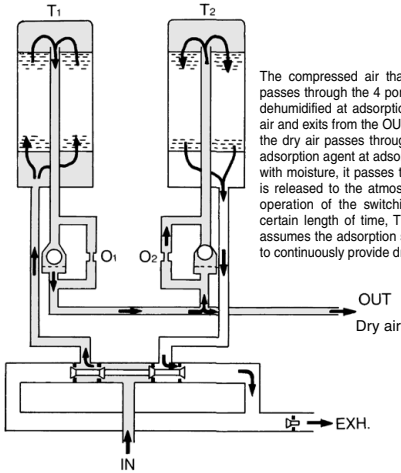

The compressed air that flowed in from the IN side passes through the 4 port solenoid valve, and after it is dehumidified at adsorption cylinder T₁, it turns into dry air and exits from the OUT side. Meanwhile, a portion of the dry air passes through orifice O₂, it reactivates the adsorption agent at adsorption cylinder T₂, and together with moisture, it passes through the solenoid valve and is released to the atmosphere. Conversely, due to the operation of the switching valve that occurs after a certain length of time, T₁ becomes reactivated and T₂ assumes the adsorption state. This process is repeated to continuously provide dry air.

Flow Rate

Inlet pressure: 0.7 MPa

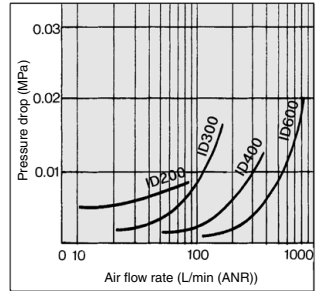

Recycled Flow Rate

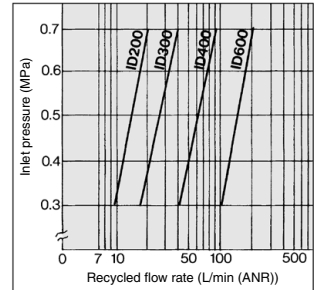

Dew Point

Condition: Air flow/Rating

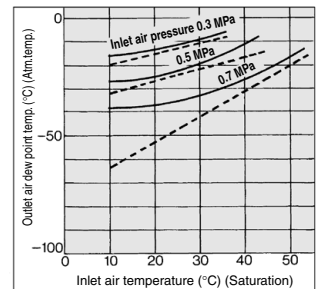

Operating System Diagram/Time Chart/Electric Circuit Diagram

Operating system diagram

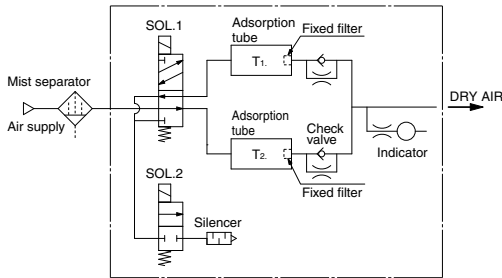

Time chart

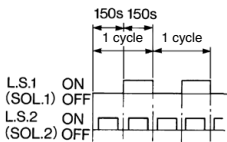

Electric circuit

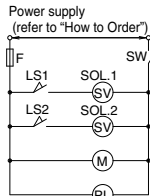

For ID□00, ID□01

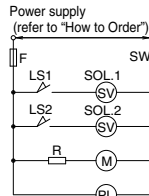

For ID□05, ID□06

Symbol	Description
SOL.1	4 port solenoid valve
SOL.2	4 port solenoid valve
F	Fuse
SW	Snap switch

Symbol	Description
PL	Light
LS1,2	Micro switch
M	Timing motor
R	Resistor

- HAA
- HAW
- AT
- IDF
- IDU
- IDFA
- IDFB
- IDH
- ID
- IDG
- IDK
- AMG
- AFF
- AM
- AMD
- AMH
- AME
- AMF
- ZFC
- SF
- SFD
- LLB
- AD□
- GD

Dimensions

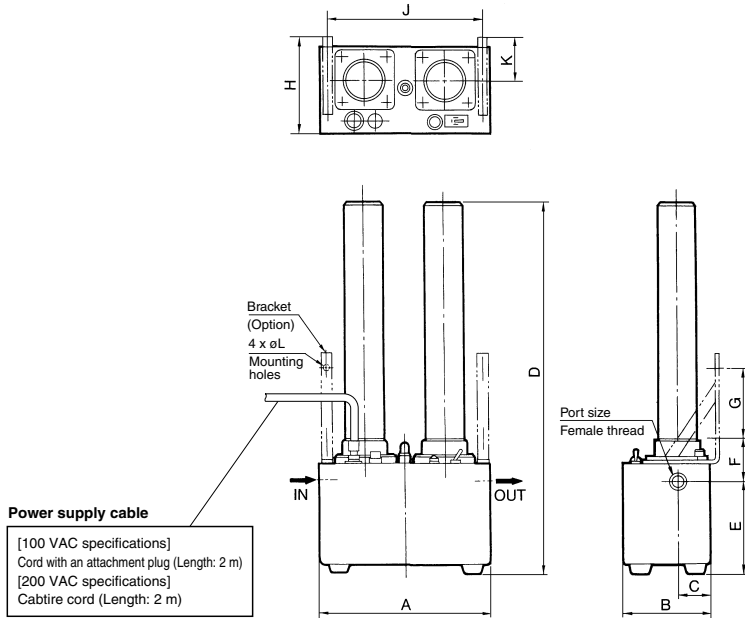

Model	Port size Nominal size (B)	A	B	C	D	E	Mounting dimension					
							F	G	H	J	K	ϕL
ID20□	1/4	240	120	45	520	128.5	59.5	95	134.5	222	59.5	9
ID30□	1/2	240	120	45	615	128.5	59.5	95	134.5	222	59.5	9
ID40□	1/2	320	170	75	850	243.5	66.5	95	183	302	88	9
ID60□	3/4	320	170	75	961	243.5	66.5	95	183	302	88	9

(mm)



Series ID Specific Product Precautions

Be sure to read before handling. Refer to front matter 43 for Safety Instructions and pages 6 to 8 for Air Preparation Equipment Precautions.

Caution on Design

⚠ Caution

1. Install this air dryer on a pneumatic line that provides a supply capacity that exceeds the required outlet air flow rate and reactivated air flow rate.
If the pneumatic line cannot provide the supply capacity indicated, the required outlet air flow rate and pressure cannot be obtained.
2. Make sure to install a mist separator on the inlet side.
If foreign matter such as oil mist or dust is present in the compressed air, the capillary tissue of the adsorption agent becomes blocked. This will substantially reduce the adsorption capacity and at the same time, shorten the life of the adsorption agent.
3. Due to a pressure fluctuation that occurs during the switching of the adsorption cylinders, the small particles of the adsorption agent could splash to the outlet side.
Install a mist separator or a micromist separator on the outlet side according to the application.
4. When installing a regulator, install it on the outlet side of the heatless air dryer.
If it is installed on the inlet side and used when the pneumatic pressure is low, the air dryer's dehumidifying capacity cannot be put into full play. (For details, refer to the performance line graph in this section.)

Piping

⚠ Caution

1. Make sure to provide a bypass pipe in case the flow of air cannot be stopped during maintenance, such as when replacing the adsorption agent.
2. Install the dryer horizontally.
3. Do not allow the weight of piping to lie directly on air dryer.
4. Do not connect a tube smaller than the port size to the inlet side. In particular, when using a resin tube, make sure that the size would not be smaller than the port size.
(Example: If ID60□ is connected to a ø12 tube, air supply may not be sufficient and it may cause malfunction due to the unstable operation of the check valve.)

Operating Environment

⚠ Caution

The air that has been used for reactivating the adsorption agent and the air that has passed through the indicator are discharged externally from the heatless air dryer. Therefore, use the dryer in an area where the discharge will not be a problem.

Operation

⚠ Caution

Turn ON the power after the air dryer has been pressurized. If the power is turned ON before it is pressurized (particularly when the pressure is low), the check valve will not operate properly, possibly creating an abnormally large reactivated air flow rate.

Maintenance

⚠ Caution

1. Replace the adsorbent according to color of the indicator.

Dew point temperature (Atmospheric pressure)	Color of indicator
-30°C or less	Dark blue
-18°C	Light blue
-10°C	Light pink

* Conditions/Inlet air pressure 0.7 MPa
Inlet air temperature 30°C

Please use the adsorbent set (refer to page 114 for "Accessory/Replacement Parts") when replacing the adsorbent.

2. Replace the element of the mist separator, installed on the inlet side, on a regular basis. (Refer to the instruction manual of the mist separator for details such as the replacement interval and procedures.)

HAA
HAW

AT

IDF
IDU

IDFA

IDFB

IDH

ID

IDG

IDK

AMG

AFF

AM

AMD

AMH

AME

AMF

ZFC

SF

SFD

LLB

AD□

GD